

Solenoid directional valves type **DKE** and **DKER**

direct operated, ISO 4401 size 10

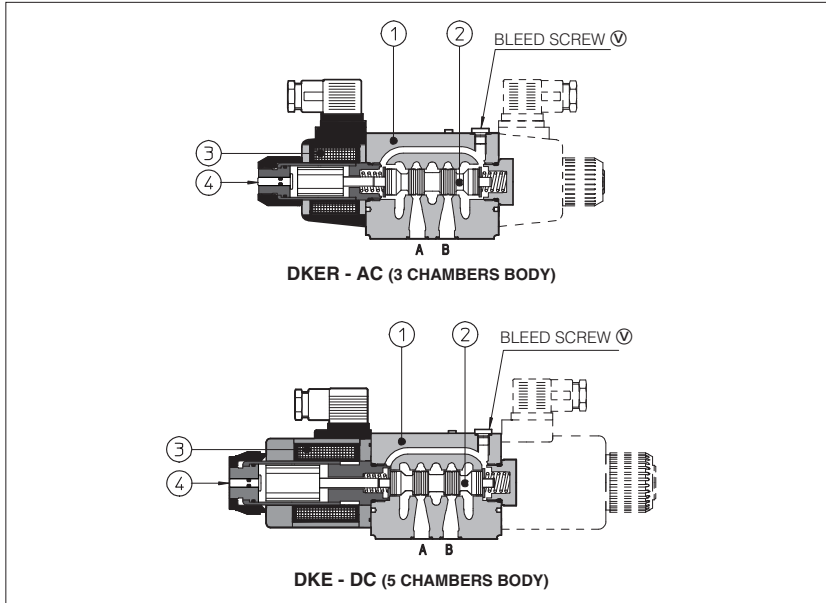

Spool type, direct operated solenoid valves available in two different versions:

DKE basic version equipped with standard solenoids

DKER high performance version equipped with improved force solenoids certified according to the North American standard **CUR US**

Configurations and construction

The valves are available in three or four way configurations and with two or three spool positions, see section 2.

The spools (2) are interchangeable and they are available in a wide range of hydraulic configurations, see section 2.

The solenoids (3) have two different executions for AC or DC power supply and they are composed by:

- wet type screwed tube with integrated manual override pin (4) (the tube are different for AC and DC power supply).
- AC and DC coils see section 5

The coils are interchangeable for the same type of power supply AC or DC and they can be easily replaced without tools (they are not interchangeable between DKE and DKER)

The coils are fully encapsulated with the following temperature classes:

- class H for DC coils
- class F for AC coils

The valve body (1) is 5 chambers type, for all DC versions and for AC version with option /F*. Standard AC version use 3 chambers type body.

The optimized internal flow paths, largely cored with extrawide channels to the tank port, ensure low pressure drops.

Options

The following optional devices are available for DKE and DKER:

- prolonged manual override protected with rubber cap for easy hand operation
- control devices of the valve switching time
- spool position monitor devices for safety applications
- external drain port Y for high tank pressure (only DC version)

Surface mounting ISO 4401 size 10
Max flow up to 150 l/min
Max pressure: 350 bar

1 MODEL CODE

DKER - 1 63 1/2 /A - X 24 DC ** /*

Directional control valves ISO 4401 size 10
DKE = standard solenoids
DKER = high performances solenoids

Valve configuration, see section 2

61 = single solenoid, center plus external position, spring centered

63 = single solenoid, 2 external positions, spring offset

67 = single solenoid, center plus external position, spring offset

70 = double solenoid, 2 external positions, without springs

71 = double solenoid, 3 positions, spring centered

75 = double solenoid, 2 external positions, with detent

Other configurations are available on request.

Spool type, see section 2

Seals material:
 omit for NBR (mineral oil & water glycol)
PE = FPM

Series number

Voltage code, see section 5

00-AC = AC solenoids without coils

00-DC = DC solenoids without coils

X = without connector

See note 2 at section 4 for available connectors, to be ordered separately

Coils with special connectors, see section 6

XJ = AMP junior Timer connector

XK = Deutsch connector (only DKE)

XS = Lead Wire connection (only DKE)

Options, see note 1 at section 4

2 CONFIGURATIONS and SPOOLS

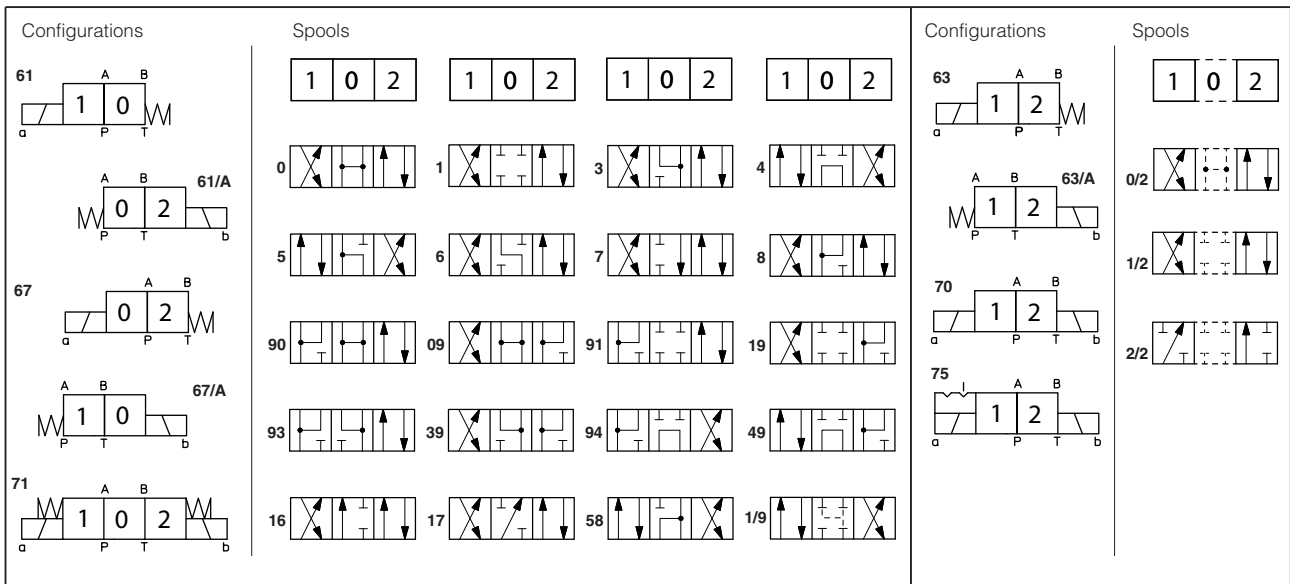

3 MAIN CHARACTERISTICS OF DKE AND DKER DIRECTIONAL VALVES

Assembly position / location	Any position for all valves except for type - 170* (without springs) that must be installed with horizontal axis if operated by impulses	
Subplate surface finishing	Roughness index Ra 0,4 - flatness ratio 0,01/100 (ISO 1101)	
Ambient temperature	from -20°C to +70°C.	
Fluid	Hydraulic oil as per DIN 51524 535; for other fluids see section 11	
Recommended viscosity	15 ÷ 100 mm ² /s at 40°C (ISO VG 15 ÷ 100)	
Fluid contamination class	ISO 4406 class 21/19/16 NAS 1638 class 10, in line filters of 25 µm (β ₂₅ ≥ 75 recommended)	
Fluid temperature	-20°C +60°C (standard seals and water glycol) -20°C +80°C (/PE seals)	
Flow direction	As shown in the symbols of table 2	
Operating pressure	DKE	Ports P, A, B: 350 bar
For versions with proximity switches (/FC, /FI and /FIE versions) port Y must be drained	DKER	Port T: 120 bar for AC solenoids; 210 bar for DC solenoids; 250 bar for option /Y Ports P,A,B: 350 bar ; Port T: 160 bar for AC solenoid; 210 bar for DC solenoids; 250 bar for option /Y
Rated flow	See diagrams Q/Δp at section 7	
Maximum flow	150 l/min , see operating limits at section 8	

4.1 Coils characteristics

Insulation class	H (180°C) for DC coils F (155°C) for AC coils Due to the occurring surface temperatures of the solenoid coils, the European standards EN ISO 13732-1 and EN ISO 4413 must be taken into account
Connector protection degree	IP 65
Relative duty factor	100%
Supply voltage and frequency	See electric feature 5
Supply voltage tolerance	± 10%
Certification (only for DKER)	cURus

4 NOTES

1 Options

- A** = Solenoid mounted at side of port B (only for single solenoid valves). In standard versions, solenoid is mounted at side of port A.
- WP** = prolonged manual override protected by rubber cap - see section 13.
- SP-WPD/KER-DC** = (only for DKER-DC) manual override with detent, to be ordered separately, see tab. K150
- L, L1, L2, L3, LR, L7, L8** see section 11 = device for switching time control (only for DC solenoids). L7 and L8 are available only for DKE with spool type 0/1, 1/1, 3/1, 4 and 5.
- F*** = 5 chambers body for DC and AC versions with proximity switch for spool position monitoring; see tab. E110.
- Y** = external drain, only for DC version, to be selected if the pressure at T port is higher than the max allowed limits.

2 Type of electric connectors DIN 43650, to be ordered separately - see section 14.

- SP-666** = standard connector IP-65 for direct connection to electric supply source.
- SP-667** = as SP-666, but with built-in signal led.
- SP-669** = with built-in rectifier bridge for supplying DC coils by alternate current (AC 110V and 230V - I_{max} 1A).

3 Spools

- spools type **0** and **3** are also available as **0/1** and **3/1** with restricted oil passages in central position, from user ports to tank.
- spools type **1** is also available as **1/1**, properly shaped to reduce the water-hammer shocks during the switching.
- spool type **1/3** (only for execution DKE(R)-1611/3/AY DC version) is particularly used as shut-off valve for safety applications, consult our technical office.
- spool type **1/9** has closed center in rest position but it avoids the pressurization of A and B ports due to the internal leakages.
- other types of spools can be supplied on request.

5 ELECTRIC FEATURES

External supply nominal voltage ± 10%	Voltage code	Type of connector	Power consumption (2)	Code of spare coil	
				DKE	DKER
12 DC	12 DC	SP-666 or SP-667	36 W (DKE) 39 W (DKER)	SP-CAE-12DC	SP-CAER-12DC
14 DC	14 DC			SP-CAE-14DC	SP-CAER-14DC
24 DC	24 DC			SP-CAE-24DC	SP-CAER-24DC
28 DC	28 DC			SP-CAE-28DC	SP-CAER-28DC
110 DC	110 DC			SP-CAE-110DC	SP-CAER-110DC
125 DC	125 DC			-	SP-CAER-125DC
220 DC	220 DC	SP-669	85 VA (DKE) 105 VA (DKER) (3)	SP-CAE-220DC	SP-CAER-220DC
110/50/60 AC	110/50/60 AC			SP-CAE-110/50/60AC (1)	SP-CAER-110/50/60AC (1)
230/50/60 AC	230/50/60 AC			SP-CAE-230/50/60AC (1)	SP-CAER-230/50/60AC (1)
115/60 AC	115/60 AC			SP-CAE-115/60AC	SP-CAER-115/60AC
230/60 AC	230/60 AC			SP-CAE-230/60AC	SP-CAER-230/60AC
110/50/60 AC	110 DC		36 W (DKE)	SP-CAE-110DC	SP-CAER-110DC
230/50/60 AC	220 DC		39 W (DKER)	SP-CAE-220DC	SP-CAER-220DC

(1) In case of 60 Hz voltage frequency the performances are reduced by 10÷15% and the power consumption is 80 VA for DKE and 90 VA for DKER.

(2) Average values based on tests performed at nominal hydraulic condition and ambient/coil temperature of 20°C.

(3) When solenoid is energized, the inrush current is approx 3 times the holding current. Inrush current values correspond to a power consumption of about 280 VA for DKE and 320 VA for DKER.

6 COILS TYPE CAE* and CAER* WITH SPECIAL CONNECTORS (only for 12DC, 14DC, 24DC and 28DC)

Options -XJ

Coil type SP-CAEJ, SP-CAERJ
AMP Junior Timer connector
Protection degree IP67

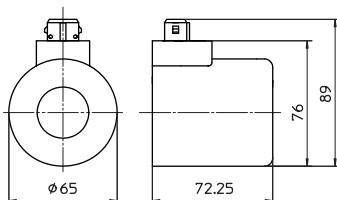

Options -XK

Coil type SP-CAEK
Deutsch connector, DT-04-2P male
Protection degree IP67

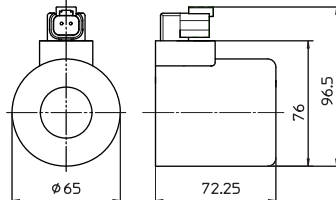

Options -XS

Coil type SP-CAES
Lead Wire connection
Cable length = 180 mm

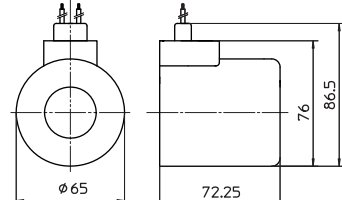

7 Q/ΔP DIAGRAMS based on mineral oil ISO VG 46 at 50°C

Flow direction \ Spool type	P→A	P→B	A→T	B→T	P→T	B→A
0, 0/1, 0/2, 2/2	A	A	B	B		
1, 1/1, 1/3, 6, 8	A	A	D	C		
3, 3/1, 7	A	A	C	D		
4	B	B	B	B	F	
5	A	B	C	C	G	
1/2	B	C	C	B		
2/7	D			F		
5/7	B			A	E	
19	A	D	C			H

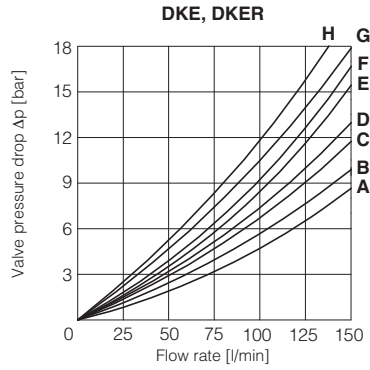

8 OPERATING LIMITS based on mineral oil ISO VG 46 at 50°C

The diagrams have been obtained with warm solenoids and power supply at lowest value ($V_{nom} - 10\%$). The curves refer to application with symmetrical flow through the valve (i.e. P→A and B→T). In case of asymmetric flow and if the valves have the devices for controlling the switching times the operating limits must be reduced.

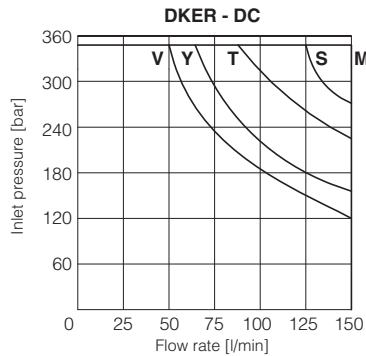
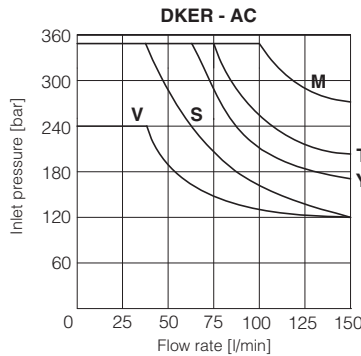
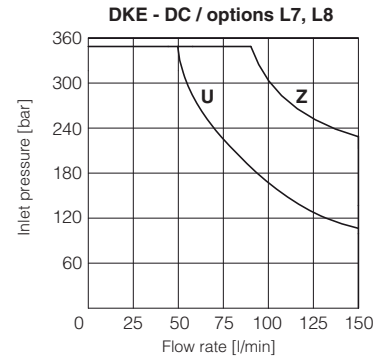
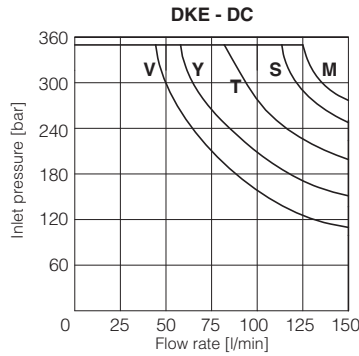
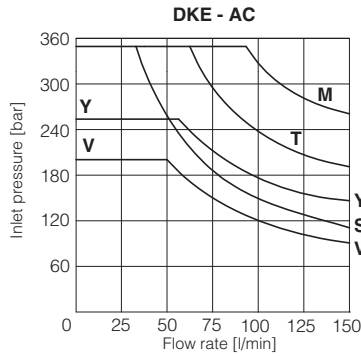

Curve	Spool type	
	AC	DC
M	0/1, 5/7, 1/3	0, 0/1, 1, 1/1, 3, 3/1, 1/2, 0/2, 8
S	2/7, 4, 5, 19	1/3, 5/7, 6, 7
Y	1, 1/2, 0/2	4, 5, 2/7
V	6, 7, 8, 2/2	2/2
T	0, 1/1, 3, 3/1	19
U	-	4, 5
Z	-	0/1, 1/1, 3/1

9 SWITCHING TIMES (average values in msec)

Valve	Switch-on AC	Switch-on DC	Switch-off AC	Switch-off DC
DKE / DKER + SP-666 / SP-667	40	60	25	35
DKE / DKER + SP-669	60	—	90	—
DKE-*/L* - DKER-*/L*	—	75÷150	—	45÷150
DKE-*/L7 - DKER-*/L8	—	100÷150	—	100÷150

Test conditions:

- 50 l/min; 150 bar
- nominal supply voltage
- 2 bar of back pressure on port T
- mineral oil ISO VG 46 at 50°C

The elasticity of the hydraulic circuit and the variations of the hydraulic characteristics and temperature affect the response time.

10 SWITCHING FREQUENCY

Valve	AC (cycles/h)	DC (cycles/h)
DKE / DKER + SP-666 / SP-667	7200	15000

11 DEVICES FOR SWITCHING TIME CONTROL

These devices are only available for DC valve version (5 chambers body) and can control the switching time and therefore reduce the coil hammering in the hydraulic circuit. The different types are available shown in the figure.

- **L**: controls and regulates the switching time in both moving directions of the spool: regulation is carried out by screwing/unscrewing the element itself (regulating choke);
- **L1/L2/L3**: controls the switching time in both moving directions of the spool by means of fixed calibrated restrictor (gauged flow). The restrictor is positioned in the valve's body
 $\varnothing L1 = 1,25 \text{ mm}$; $\varnothing L2 = 1 \text{ mm}$; $\varnothing L3 = 0,75 \text{ mm}$;
- **LR**: controls and regulates the switching time in the B→A direction of the spool movement. The device does not control the switching time (standard time) in the opposite direction A→B of the spool movement.
- **L7/L8**: controls the switching time in both moving directions of the spool by means of fixed calibrated restrictor (gauged flow). The restrictor is installed in the solenoid's anchor.

For a correct operation of the switching time control, the passage in which the control device is installed must be completely filled with oil.

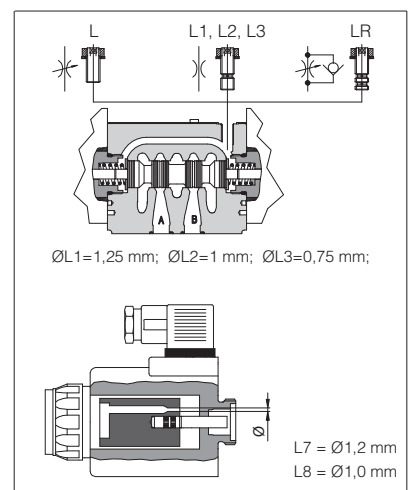

12 INSTALLATION DIMENSIONS [mm]

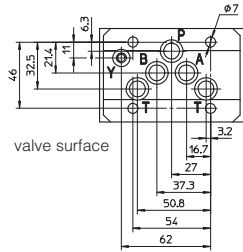

ISO 4401: 2005
Mounting surface according to 4401-05-05-05
 (without X port, Y port optional)
 Fastening bolts:
 4 socket head screws M6x40 class 12.9
 Tightening torque = 15 Nm
 Seals: 5 OR 2050 and 1 OR 108
 Ports P,A,B,T: Ø = 11.5 mm (max)
 Ports Y: Ø = 5 mm

P = PRESSURE PORT
A, B = USE PORT
T = TANK PORT
Y = DRAIN PORT (only for option /Y)
 For the max pressures on ports, see section 3

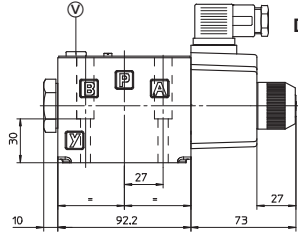

DKER-16*-AC

Mass: 3,6 kg

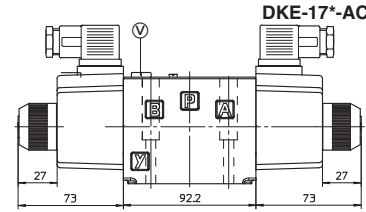
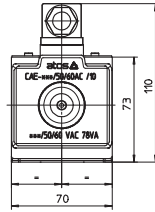

DKER-17*-AC

Mass: 4,3 kg

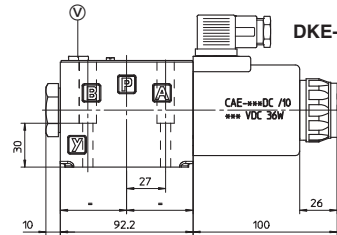

DKER-16*-DC

Mass: 4,2 kg

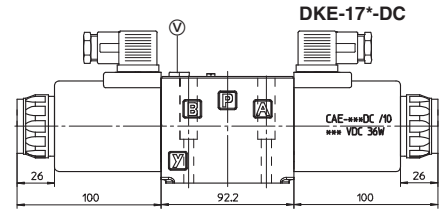
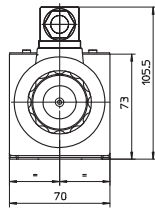

DKER-17*-DC

Mass: 5,7 kg

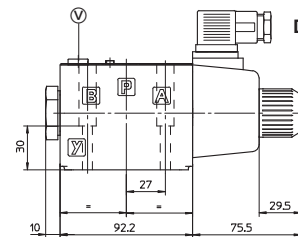

DKER-16*-AC

Mass: 3,6 kg

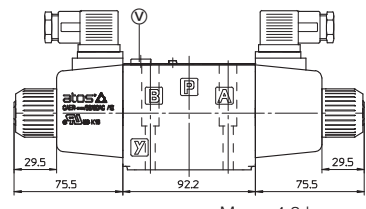
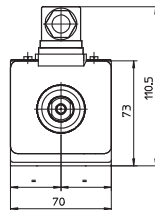

DKER-17*-AC

Mass: 4,3 kg

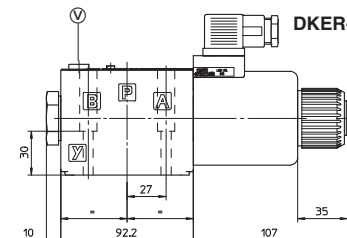

DKER-16*-DC

Mass: 4,4 kg

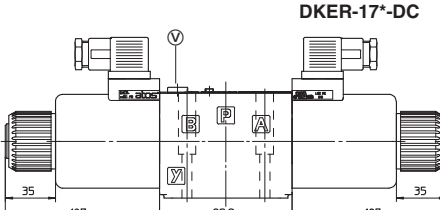
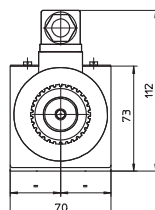

DKER-17*-DC

Mass: 5,9 kg

Overall dimensions refer to valves with connectors type SP-666

13 OPTION /WP

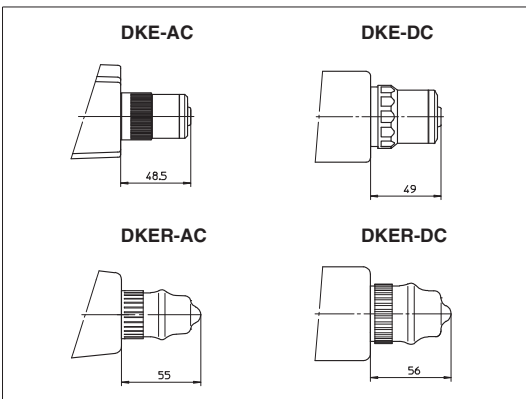

14 ELECTRIC CONNECTORS ACCORDING TO DIN 43650

The connectors must be ordered separately

SP-666, SP-667 (for AC or DC supply) 		SP-669 (for AC supply) 	
CONNECTOR WIRING			
SP-666, SP-667 1 = Positive ⊕ 2 = Negative ⊖ ⊕ = Coil ground		SP-669 1,2 = Supply voltage V _{AC} 3 = Coil ground	
SUPPLY VOLTAGES			
SP-666 All voltages	SP-667 24 AC or DC 110 AC or DC 220 AC or DC	110/50 AC 110/60 AC 115/60 AC 230/50 AC 230/60 AC	

15 MOUNTING SUBPLATES

Model	Ports location	GAS Ports A-B-P-T (X-Y)	Ø Counterbore [mm] A-B-P-T (X-Y)	Mass [kg]
BA-308 (Y)	Ports A, B, P, T (X, Y) underneath	1/2" (1/4")	30 (21,5)	2,5
BA-428 (Y)	Ports A, B, P, T (X, Y) underneath	3/4" (1/4")	36,5 (21,5)	5,5
BA-434 (Y)	Ports P, T, (X, Y) underneath; ports A, B on lateral side	3/4" (1/4")	36,5 (21,5)	8,5

The subplates are supplied with 4 fastening bolts M6x40. Also available are multi-station subplates and modular subplates. For further details see table K280.