

Technical
Information

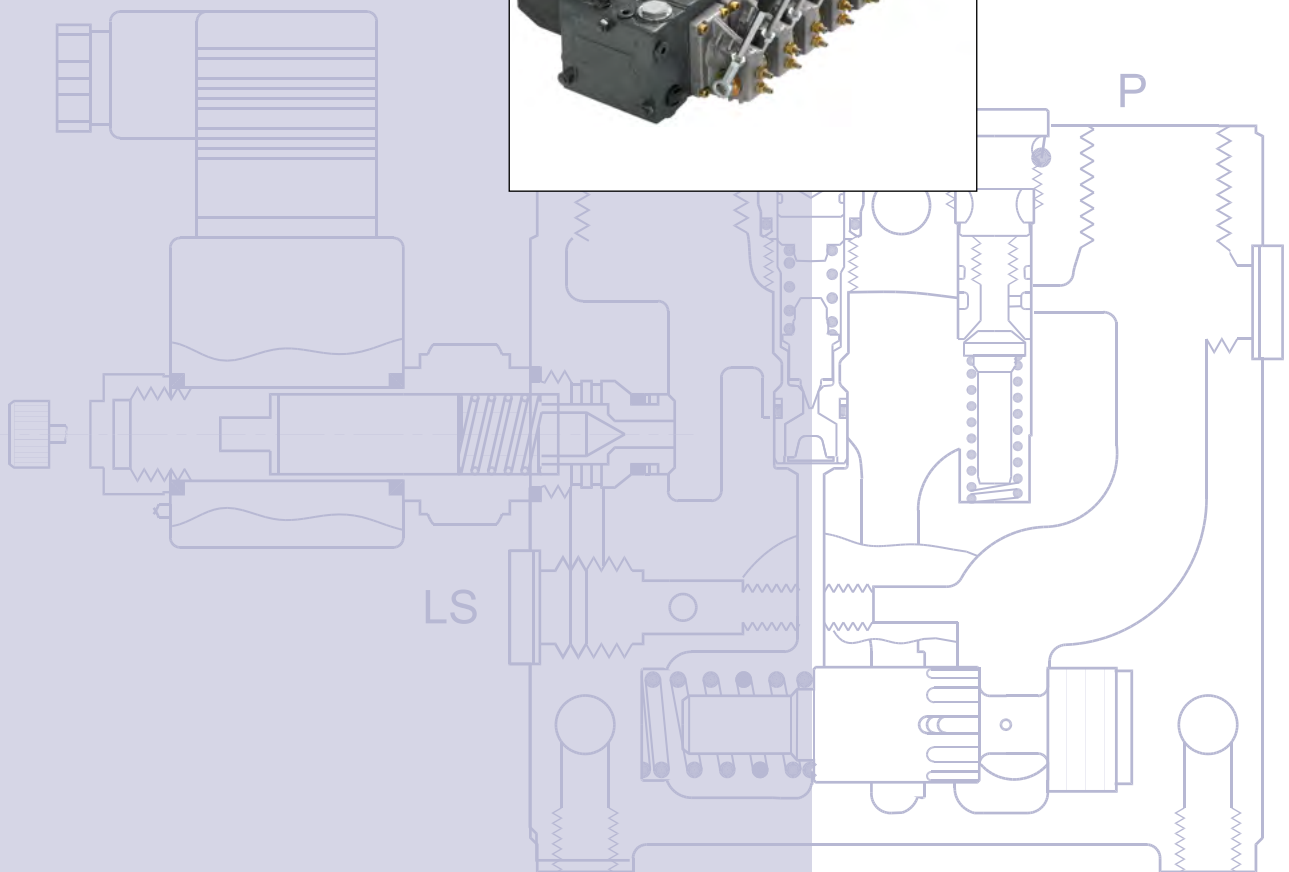

Revision History

Table of revisions

Date	Page	Changed	Rev
Jun 2010	69	Code numbers changed	GD
Dec 2010	80	New back cover	GE
Sep 2012	All	Major update	HA
Oct 2012	15,23,24,51,63	New images, notes	HB
Aug 2013	62	New image	HC

Literature Reference

Literature reference for PVG products

Title	Type	Order number
PVG 32 Metric ports	Technical Information	11051935
PVG 100	Technical Information	520L0720
PVG 120 Proportional Valve	Technical Information	520L0356
Basic Module for PVBZ	Technical Information	520L0721
PVSK Module with Integrated Diverter Valve and P-disconnect Function	Technical Information	520L0556
PVED-CC Electrohydraulic actuator	Technical Information	520L0665
PVED-CX Electrohydraulic actuator, Series 4	Technical Information	11070179
PVE Series 4	Technical Information	520L0553
PVPV / PVPVM Pump Side Module	Technical Information	520L0222
Electrohydraulic Actuator Type PVHC for PVG 32 and PVG 100	Technical Information	11064912
Combination Module PVGI	Technical Information	520L0405
PVSP/M Priority Module	Technical Information	520L0291
PVBM Meter-in Meter-out Module	Datasheet	L1117392

This PVG 32 catalog lists modules without T0 facilities, for more information regarding T0 facilities please see *PVG 32 Metric port*, **11051935** and *Basic module PVBZ*, **520L0721**.

© 2013 Sauer-Danfoss. All rights reserved.

Sauer-Danfoss accepts no responsibility for possible errors in catalogs, brochures and other printed material. Sauer-Danfoss reserves the right to alter its products without prior notice. This also applies to products already ordered provided that such alterations can be made without affecting agreed specifications. All trademarks in this material are properties of their respective owners. Sauer-Danfoss, the Sauer-Danfoss logotype, the Sauer-Danfoss S-icon, PLUS+1®, What really matters is inside® and Know-How in Motion™ are trademarks of the Sauer-Danfoss Group.

Frontpage: F301302, F301306, F301056, Drawing 157-195.

General Information

General Description.....6
 Features of PVG 32.....6
 PVG Modules.....6
 PVP, pump side modules6
 PVB, basic modules6
 Actuation modules.....7
 Remote control units7
 Accessories7
 Safety in Application8
 FMEA (Failure Mode and Effect Analysis) IEC EN 61508.....8
 Hazard and Risk Analysis ISO 12100-1 / 14121.....8
 Control System Examples9
 PVG32 – Mainly used in system with fixed displacement pumps.....11
 PVG100 – Alternative LS dump or pilot supply disconnect.....11
 PVG120 – Pump disconnect/block for variable pumps11
 PVG 32 with Open Center PVP (fixed displacement pump)12
 PVG 32 with Closed Center PVP (variable displacement pump)13
 PVG 32 Sectional View14
 Load Sensing for Variable Displacement Pump Supply15

Function

Load Sensing Controls.....16
 Remote Pressure Compensated Controls.....17
 Remote pressure compensated system characteristics:.....17
 Typical applications for remote pressure compensated systems:17
 PVG 32 Main Spool with Pressure Compensated Control18
 Pressure compensated system characteristics.....18
 Typical applications for pressure compensated systems18
 PVPC Adapter for External Pilot Oil Supply19
 PVPC with check valve for open center PVP19
 PVPC without check valve for open or closed center PVP20
 PVMR, Friction Detent.....21
 PVMF, Mechanical Float Position Lock.....21
 PVBS, Main Spools for Flow Control (Standard)22
 PVBS, Main Spools for Pressure Control22
 PVBS, Main Spools for Flow Control (with Linear Characteristic).....22
 Background.....23
 Principle.....24
 Application.....25
 Limitation.....25
 PVPX, Electrical LS Unloading Valve26

Technical Data

PVG 3227
 PVH, Hydraulic Actuation28
 PVM, Mechanical Actuation.....28
 PVE Technical Data.....29
 PVPX, Electrical LS Unloading Valve32

Electrical Actuation	Electrical control of PVG.....	33
	Closed loop control.....	35
	PVEO.....	36
	PVEM.....	36
	PVEA/H/S/U	37
	PVEP	37
	PVED-CC and PVED-CX.....	38
	PVHC	39
Modules and Code Numbers	PVP, Pump Side Modules	40
	PVP, Pump Side Modules	41
	PVB, Basic Modules – Without Adjustable $LS_{A/B}$ Pressure Limiting Valves.....	42
	PVB, Basic Modules - Without Adjustable $LS_{A/B}$ Pressure Limiting Valves.....	43
	PVB, Basic Modules - With Adjustable $LS_{A/B}$ Pressure Limiting Valves	44
	PVLA, Suction Valve (fitted in PVB).....	45
	PVLP, Shock and Suction Valve (Fitted in PVB)	45
	PVM, Mechanical Actuation.....	46
	PVMD, Cover for Mechanical Actuation	46
	PVMR, Friction Detent.....	46
	PVMF, Mechanical Float Position	46
	PVH, Hydraulic Actuation	46
	PVS, End Plate.....	47
	PVAS, Assembly Kit	47
	PVPX, Electrical LS Unloaded Valve.....	48
	PVPC, Plug for External Pilot Oil Supply	48
Technical Characteristics	General.....	49
	PVP, Pump Side Module	49
	PVB.....	50
	Oil flow characteristics	50
	Pressure-compensated PVB, open or closed center PVP	50
	PVB, Basic Modules	51
	PVB without pressure compensation, open center PVP	52
	PVB without pressure compensation, closed center PVP	54
	PVLP, Shock and Suction Valve	57
	PVLA, Suction Valve	57
	Pressure Control Spool Flow Characteristics in Various Positions	58
	Pressure Build-up for Pressure Controlled Spools	59
	Examples of How To Use the Characteristics for Pressure Control Spools.....	59
	Characteristics for Float Position Main Spools.....	60

Dimensions	Dimensions.....	62
	Control Lever Positions	64
	Surface Treatment.....	64
Hydraulic Systems	Manually Actuated PVG 32 – Fixed Displacement Pump	65
	Electrically Actuated PVG 32 – Variable Displacement Pump.....	66
Other Operating Conditions	Oil	67
	Filtration.....	68
Module Selection Chart	Standard FC Spools.....	69
	FC Spools for Mechanical Float Position PVMF.....	71
	Standard FC Spools, Hydraulic Actuation.....	72
	PVMR, FC Spools for Friction Detent	72
	FC Spools with Linear Flow Characteristic	73
	Standard PC Spools	74
	Standard PC Spools, Hydraulic Actuation	76
	PVB, basic valves	77
	PVPC, plugs.....	77
	PVM, mechanical actuation	77
	PVAS, assembly kit	77
	PVP, pump side module	78
	PVLP, shock/ and anti-cavitation valves	78
	PVPX, electrical LS pressure relief valves	78
	PVS and PVS1, End plate	78
	PVE, electrical actuation.....	79
	PVMD, PVMR, PVMF, PVH covers	79
PVLA, anti-cavitation valve	79	
Order Specification	Order Specification	80
	Order Specification Forms.....	82

General Description

PVG 32 is a hydraulic load sensing valve designed to give maximum flexibility. From a simple load sensing directional valve, to an advanced electrically controlled load-independent proportional valve.

The PVG 32 modular system makes it possible to build up a valve group to meet requirements precisely. The compact external dimensions of the valve remain unchanged whatever combination is specified.

Features of PVG 32

- Load-independent flow control:
 - Oil flow to an individual function is independent of the load pressure of this function
 - Oil flow to one function is independent of the load pressure of other functions
- Good regulation characteristics
- Energy-saving
- Up to 12 basic modules per valve group
- Several types of connection threads
- Low weight
- Compact design and installation



PVG Modules

PVP, pump side modules

- Built-in pressure relief valve
- Pressure gauge connection
- Versions:
 - Open center version for systems with fixed displacement pumps
 - Closed center version for systems with variable displacement pumps
 - Pilot oil supply for electrical actuator built into the pump side module
 - Pilot oil supply for hydraulic actuation built into the pump side module
 - Versions prepared for electrical LS unloading valve PVPX

PVB, basic modules

- Interchangeable spools
- Depending on requirements the basic module can be supplied with:
 - Integrated pressure compensator in channel P
 - Load holding check valve in channel P
 - Shock/suction valves for A and B ports
 - LS pressure limiting valves individually adjustable for ports A and B
 - Different interchangeable spool variants
 - All versions suitable for mechanical, hydraulic and electrical actuation

PVG Modules (continued) Actuation modules

The basic module is always fitted with mechanical actuator PVM and PVMD, which can be combined with the following as required:

- Electrical actuator (11 - 32 V $\overline{=}$):
 - PVES – proportional, Super
 - PVEH – proportional, High performance
 - PVEH-F – proportional high performance, Float
 - PVEA – proportional low hysteresis
 - PVEM – proportional, Medium performance
 - PVEO – ON/OFF
 - PVEU – proportional, voltage control, 0-10 V
 - PVED-CC – Digital CAN controlled J1939/ISOBUS
 - PVED-CX – Digital CAN controlled CANopen X-tra safety
 - PVEP – PWM voltage controlled (11-32V)
 - PVHC – High Current actuator for PVG
- PVMR, cover for Mechanical detent
- PVMF, cover for Mechanical Float
- PVH, cover for Hydraulic actuation

Accessories**Remote control units**

- Electrical remote control units:
 - PVRE, PVRET
 - PVREL
 - PVRES
 - Prof 1
 - Prof 1 CIP
 - JS120
 - JS1000 Ball grip
 - JS1000 PROgrip
 - JS2000
 - JS6000
 - JS7000
- Hydraulic remote control unit:
 - PVRHH

Safety in Application

All makes and all types of control valves (incl. proportional valves) can fail, thus the necessary protection against the serious consequences of function failure should always be built into the system. For each application an assessment should be made for the consequences of pressure failure and uncontrolled or blocked movements.

To determine the degree of protection that is required to be built into the application, system tools such as an FMEA (Failure Mode and Effect Analysis) and Hazard and Risk Analysis can be used.

FMEA (Failure Mode and Effect Analysis) IEC EN 61508

FMEA is a tool used for analyzing potential risks. This analytical technique is utilized to define, identify, and prioritize the elimination or reduction of known and/or potential failures from a given system before it is released for production.

Please refer to IEC FMEA Standard 61508.

Hazard and Risk Analysis ISO 12100-1 / 14121

This analysis is a tool used in new applications as it will indicate whether there are special safety considerations to be met according to the machine directives EN 13849. Dependent on the determined levels conformity this analysis will determine if any extra requirements for the product design, development process, production process or maintenance, i.e. the complete product life cycle.

⚠ Warning

All makes/brands and types of directional control valves – inclusive proportional valves – can fail and cause serious damage. It is therefore important to analyze all aspects of the application.

Because the proportional valves are used in many different operation conditions and applications, the manufacturer of the application is alone responsible for making the final selection of the products – and assuring that all performance, safety and warning requirements of the application are met.

The process of choosing the control system – and safety levels – is governed by the machine directives EN 13849 (Safety related requirements for control systems).

**Safety in Application
 (continued)**

Control System Examples

Example of a control system for manlift using PVE Fault monitoring input signals and signals from external sensors to ensure the PLUS+1™ main controllers correct function of the manlift.

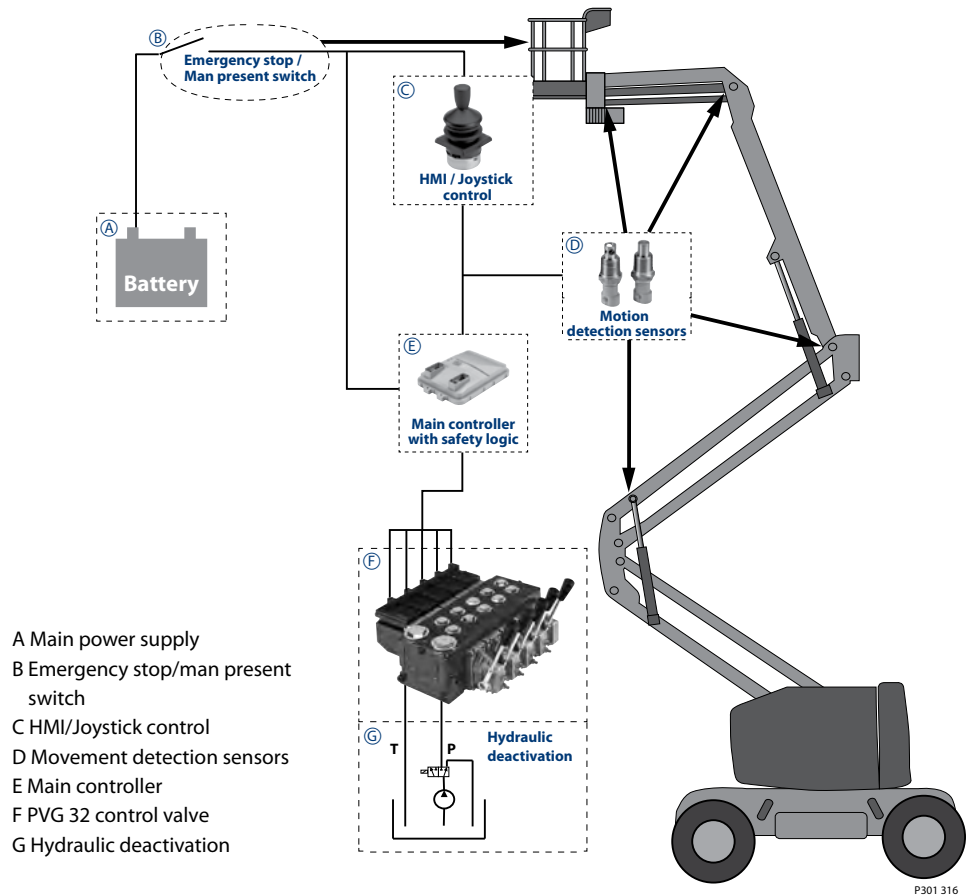

P301 316

Warning

It is the responsibility of the equipment manufacturer that the control system incorporated in the machine is declared as being in conformity with the relevant machine directives.

Electrical block diagram for above illustration

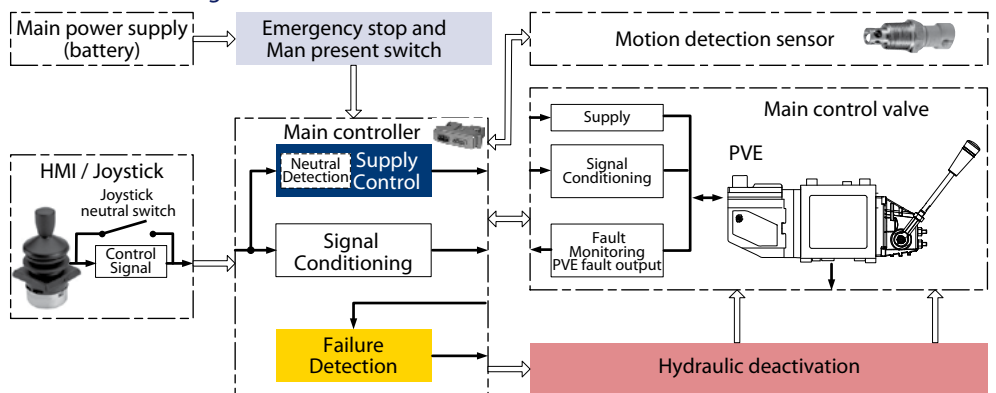

P301 317

**Safety in Application
 (continued)**

Example of a typical wiring block diagram using PVEH with neutral power off switch and fault monitoring output for hydraulic deactivation.

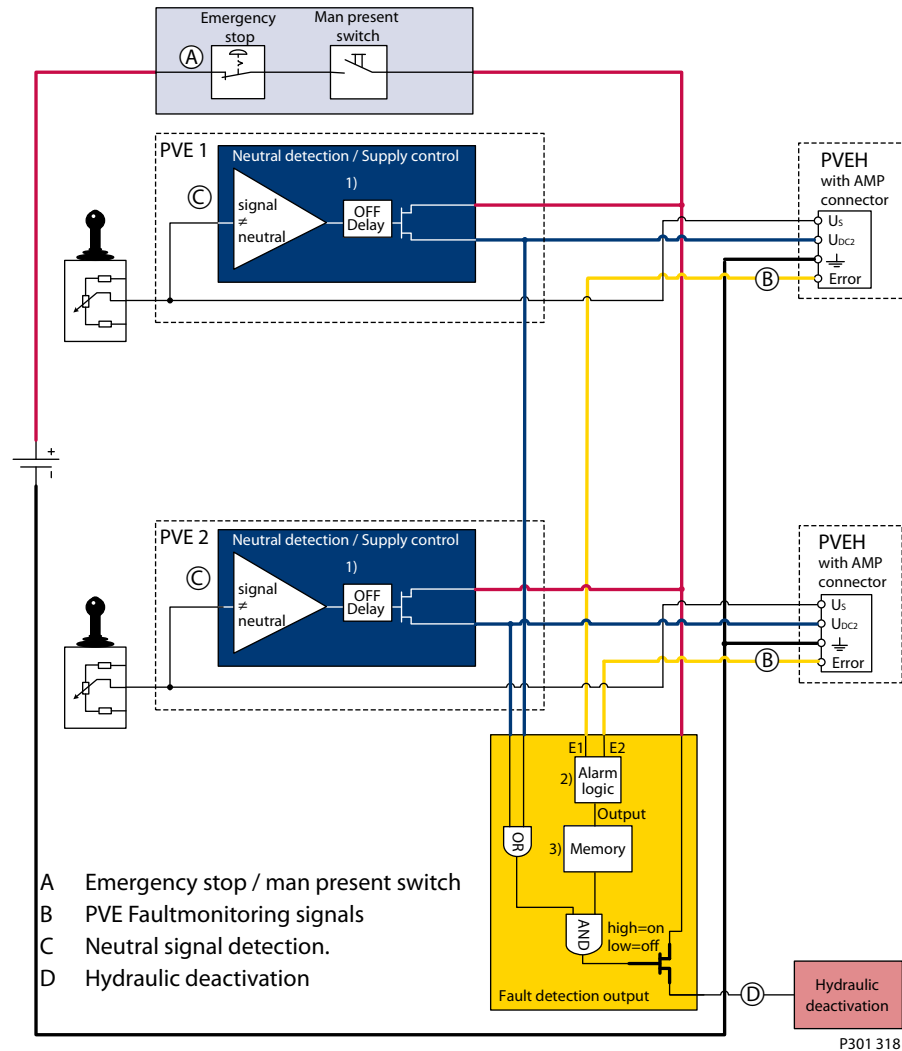

System Control Logic e.g. PLUS+1™ for signal monitoring and triggering signal for deactivation of the hydraulic system.

Warning

It is the responsibility of the equipment manufacturer that the control system incorporated in the machine is declared as being in conformity with the relevant machine directives.

**Safety in Application
 (continued)**

Example of fault monitoring for deactivation of the hydraulic system with extra fault inputs using the PVE's with DI (Direction Indication) function.

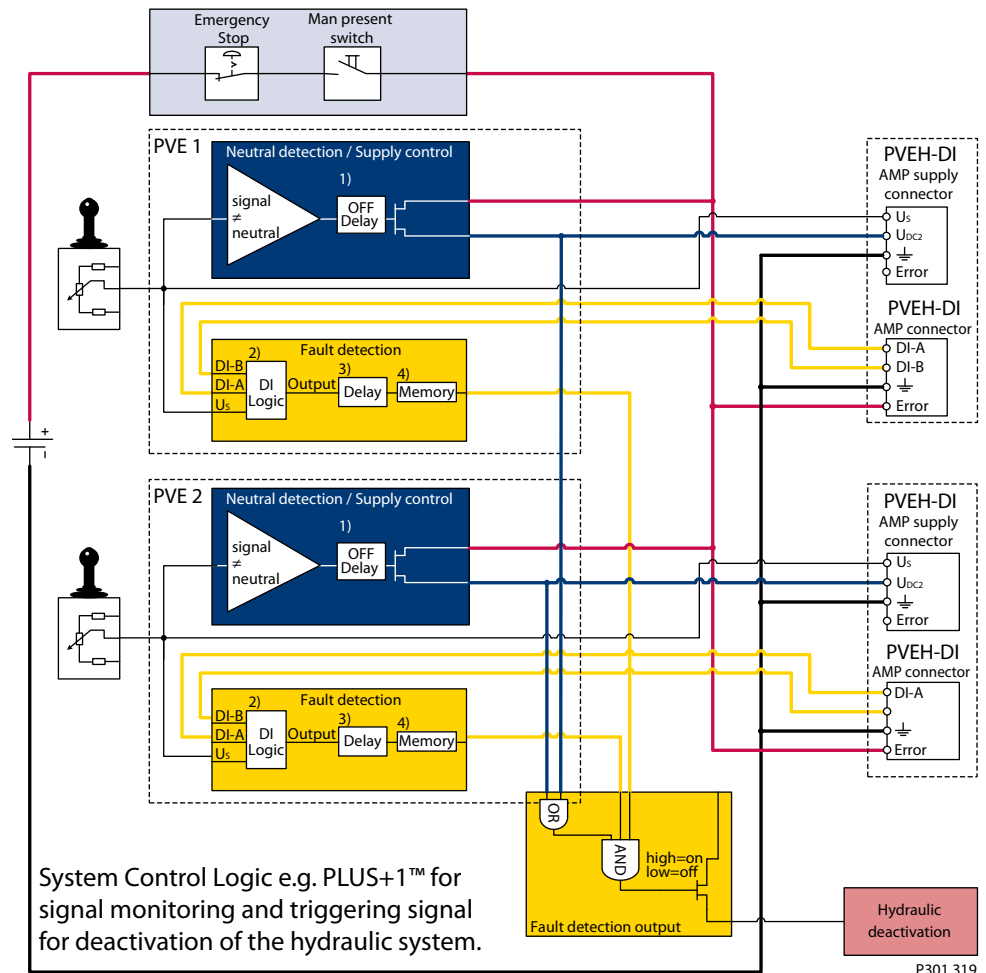

Warning

It is the responsibility of the equipment manufacturer that the control system incorporated in the machine is declared as being in conformity with the relevant machine directives.

Other modules which can be used in connection with hydraulic deactivation at different levels.

PVG32 – Mainly used in system with fixed displacement pumps

- PVSK, commonly used in crane application - full flow dump
- PVPX, LS dump to tank

PVG100 – Alternative LS dump or pilot supply disconnect

- PVPP, pilot oil supply shut off
- External cartridge valve connecting LS Pressure to Tank
- External cartridge valve connecting main Pressure to Tank

PVG120 – Pump disconnect/block for variable pumps

- PVPE, full flow dump for the PVG 120
- External cartridge valve connecting LS Pressure to Tank

**PVG 32 with Open Center
PVP (fixed displacement
pump) • PVB with Flow
Control Spool**

When the pump is started and the main spools in the individual basic modules (11) are in the neutral position, oil flows from the pump, through connection P, across the pressure adjustment spool (6) to tank. The oil flow led across the pressure adjustment spool determines the pump pressure (stand-by pressure).

When one or more of the main spools are actuated, the highest load pressure is fed through the shuttle valve circuit (10) to the spring chamber behind the pressure adjustment spool (6), and completely or partially closes the connection to tank to maintain pump pressure.

Pump pressure is applied to the right-hand side of the pressure adjustment spool (6). The pressure relief valve (1) will open should the load pressure exceed the set value, diverting pump flow back to tank.

In a pressure-compensated basic module the compensator (14) maintains a constant pressure drop across the main spool – both when the load changes and when a module with a higher load pressure is actuated.

With a non pressure-compensated basic module incorporating a load drop check valve (18) in channel P, the check valve prevents return oil flow.

The basic module can be supplied without the load drop check valve in channel P for functions with over-center valves.

The shock valves PVLP (13) with fixed setting and the suction valves PVLA (17) on ports A and B are used for the protection of the individual working function against overload and/or cavitation.

An adjustable LS pressure limiting valve (12) can be built into the A and B ports of pressure-compensated basic modules to limit the pressure from the individual working functions.

Please see *The sectional drawing V310106.A* on the next page for better understanding of this example.

The LS pressure limiting valves save energy compared with the shock valves PVLP:

- with PVLP all the oil flow to the working function will be led across the combined shock and suction valves to tank if the pressure exceeds the fixed setting.
- with LS pressure limiting valves an oil flow of about 2 l/min [0.5 US gal/min] will be led across the LS pressure limiting valve to tank if the pressure exceeds the valve setting.

**PVG 32 with Closed
Center PVP (variable
displacement pump) •
PVB with Flow Control
Spool**

In the closed center version of PVP an orifice (5) and a plug (7) have been fitted instead of the plug (4). This means that the pressure adjustment spool (6) will only open to tank when the pressure in channel P exceeds the set value of the pressure relief valve (1).

In load sensing systems the load pressure is led to the pump control via the LS connection (8).

In the neutral position the pump load sense control sets the displacement so that leakage in the system is compensated, to maintain the set stand-by pressure. When a main spool is actuated the pump load sense control will adjust the displacement so that the set differential pressure (margin) between P and LS is maintained.

The pressure relief valve (1) in PVP should be set at a pressure of approx. 30 bar [435 psi] above maximum system pressure (set on the pump or external pressure relief valve).

PVG 32 Sectional View

PVG 32 Sectional Drawing

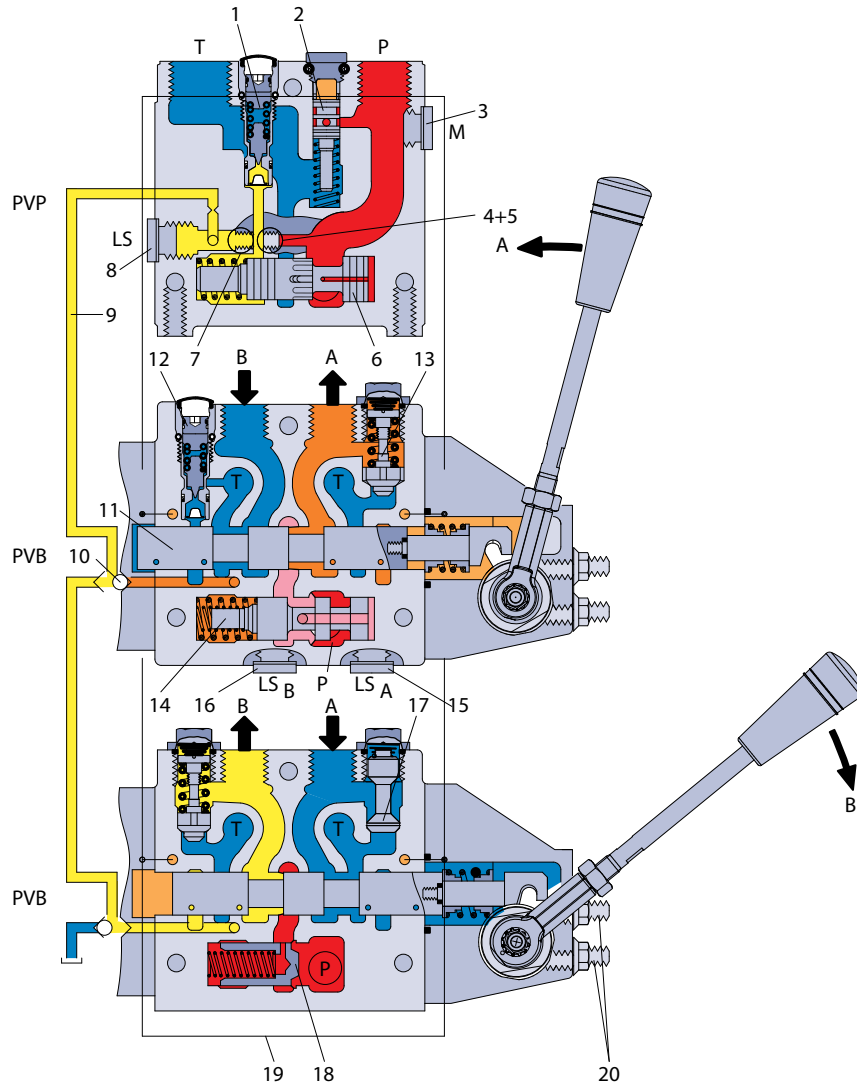

V310106.A

- | | | | |
|-----|---|-----|---|
| 1. | Pressure relief valve | 11. | Main spool |
| 2. | Pressure reduction valve for pilot oil supply | 12. | LS pressure limiting valve |
| 3. | Pressure gauge connection | 13. | Shock and suction valve, PVL P |
| 4. | Plug, open center | 14. | Pressure compensator |
| 5. | Orifice, closed center | 15. | LS connection, port A |
| 6. | Pressure adjustment spool | 16. | LS connection, port B |
| 7. | Plug, closed center | 17. | Suction valve, PVLA |
| 8. | LS connection | 18. | Load drop check valve |
| 9. | LS signal | 19. | Pilot oil supply for PVE |
| 10. | Shuttle valve | 20. | Max. oil flow adjustment screws for ports A and B |

Load Sensing for Variable Displacement Pump Supply

The pump receives fluid directly from the reservoir through the inlet line. A screen in the inlet line protects the pump from large contaminants. The pump outlet feeds directional control valves such as PVG-32, hydraulic integrated circuits (HIC), and other types of control valves. The PVG valve directs and controls pump flow to cylinders, motors and other work functions. A heat exchanger cools the fluid returning from the valve. A filter cleans the fluid before it returns to the reservoir.

Flow in the circuit determines the speed of the actuators. The position of the PVG valve spool determines the flow demand. A hydraulic pressure signal (LS signal) communicates demand to the pump control. The pump control monitors the pressure differential between pump outlet and the LS signal, and regulates servo pressure to control the swashplate angle. Swashplate angle determines pump flow.

Actuator load determines system pressure. The pump control monitors system pressure and will decrease the swashplate angle to reduce flow if system pressure reaches the pump control setting. A secondary system relief valve in the PVG valve acts as a back-up to control system pressure.

Pictorial circuit diagram

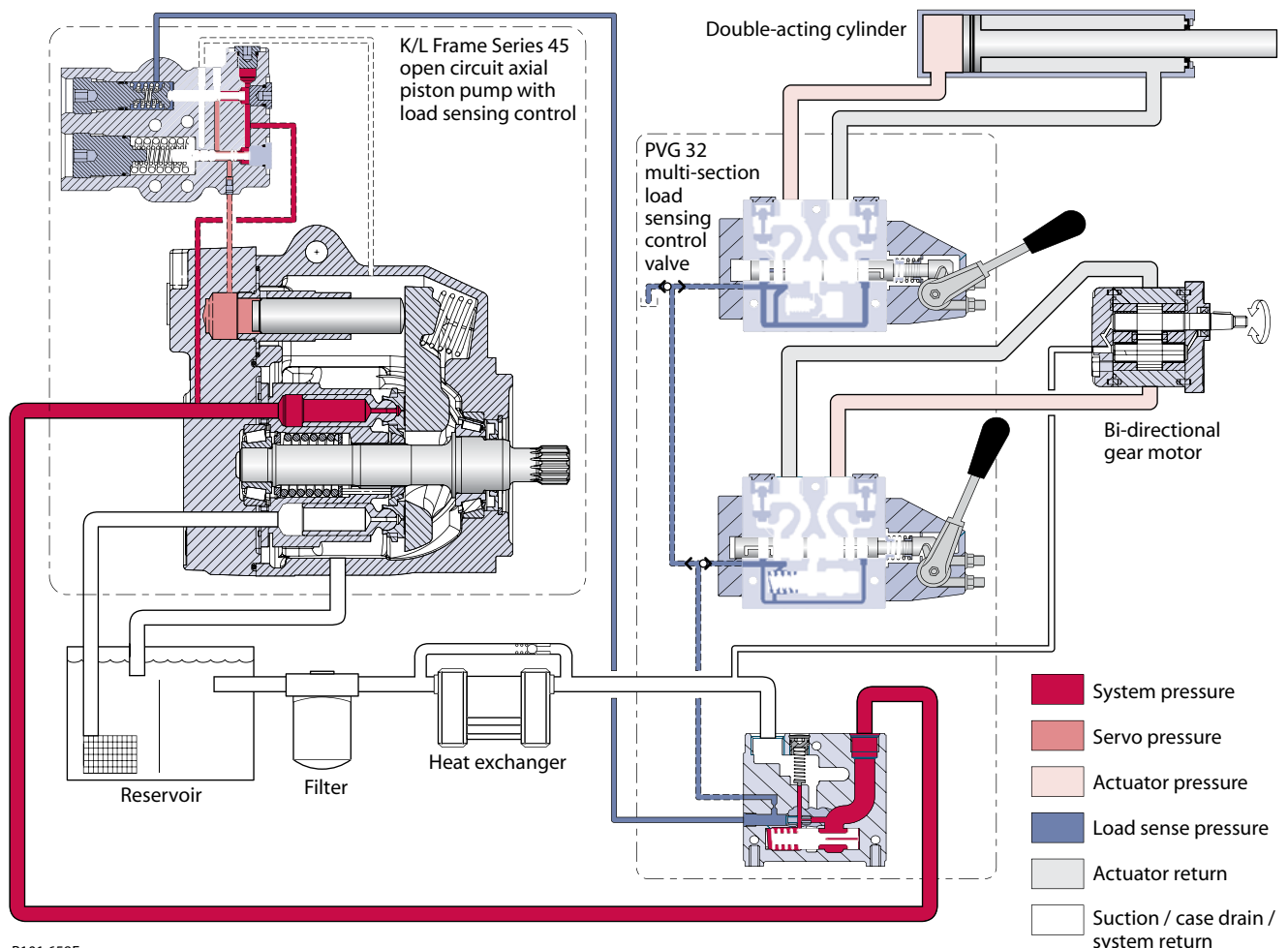

P101 658E

Load Sensing Controls

The LS control matches system requirements for both pressure and flow in the circuit regardless of the working pressure. Used with a closed center control valve, the pump remains in low-pressure standby mode with zero flow until the valve is opened. The LS setting determines standby pressure.

Typical operating curve

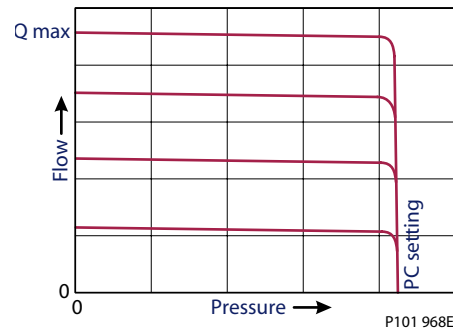

Load sensing circuit

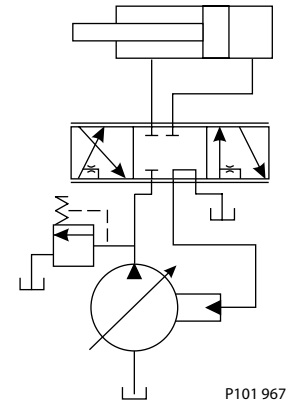

Most load sensing systems use parallel, closed center, control valves with special porting that allows the highest work function pressure (LS signal) to feed back to the LS control.

Margin pressure is the difference between system pressure and the LS signal pressure. The LS control monitors margin pressure to read system demand. A drop in margin pressure means the system needs more flow. A rise in margin pressure tells the LS control to decrease flow.

LS control with bleed orifice (do not use with PVG valves)

The load sense signal line requires a bleed orifice to prevent high-pressure lockup of the pump control. Most load-sensing control valves include this orifice. An optional internal bleed orifice is available, for use with control valves that do not internally bleed the LS signal to tank.

Integral PC function

The LS control also performs as a PC control, decreasing pump flow when system pressure reaches the PC setting. The pressure compensating function has priority over the load sensing function.

For additional system protection, install a relief valve in the pump outlet line.

Load sensing system characteristics:

- Variable pressure and flow
- Low pressure standby mode when flow is not needed
- System flow adjusted to meet system requirements
- Lower torque requirements during engine start-up
- Single pump can supply flow and regulate pressure for multiple circuits
- Quick response to system flow and pressure requirements

**Remote Pressure
 Compensated Controls**

The remote PC control is a two-stage control that allows multiple PC settings. Remote PC controls are commonly used in applications requiring low and high pressure PC operation.

Typical operating curve

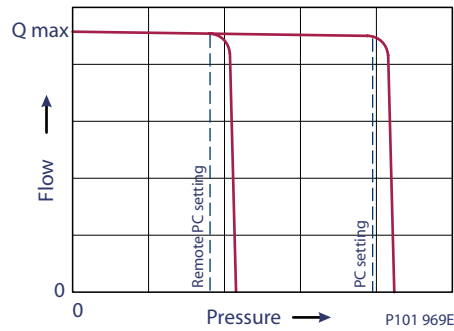

Closed center circuit with remote PC

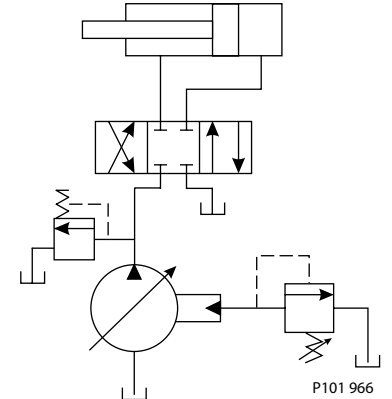

The remote PC control uses a pilot line connected to an external hydraulic valve. The external valve changes pressure in the pilot line, causing the PC control to operate at a lower pressure. When the pilot line is vented to reservoir, the pump maintains pressure at the load sense setting. When pilot flow is blocked, the pump maintains pressure at the PC setting. An on-off solenoid valve can be used in the pilot line to create a low-pressure standby mode. A proportional solenoid valve, coupled with a microprocessor control, can produce an infinite range of operating pressures between the low pressure standby setting and the PC setting.

Size the external valve and plumbing for a pilot flow of 3.8 l/min [1 US gal/min].
 For additional system protection, install a relief valve in the pump outlet line.

Remote pressure compensated system characteristics:

- Constant pressure and variable flow
- High or low pressure standby mode when flow is not needed
- System flow adjusts to meet system requirements
- Single pump can provide flow to multiple work functions
- Quick response to system flow and pressure requirements

Typical applications for remote pressure compensated systems:

- Modulating fan drives
- Anti-stall control with engine speed feedback
- Front wheel assist
- Road rollers
- Combine harvesters
- Wood chippers

PVG 32 Main Spool with Pressure Compensated Control

The PC control maintains constant system pressure in the hydraulic circuit by varying the output flow of the pump. Used with a closed center control valve, the pump remains in high pressure standby mode at the PC setting with zero flow until the function is actuated.

Typical operating curve

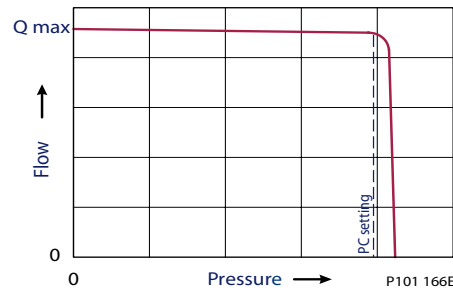

Simple closed-center circuit

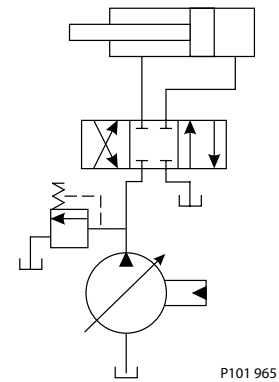

Once the closed center valve is opened, the PC control senses the immediate drop in system pressure and increases pump flow by increasing the swashplate angle. The pump continues to increase flow until system pressure reaches the PC setting. If system pressure exceeds the PC setting, the PC control reduces the swashplate angle to maintain system pressure by reducing flow. The PC control continues to monitor system pressure and changes swashplate angle to match the output flow with the work function pressure requirements. If the demand for flow exceeds the capacity of the pump, the PC control directs the pump to maximum displacement. In this condition, actual system pressure depends on the actuator load.

For additional system protection, install a relief valve in the pump outlet line.

* Do not use the PVG 32 with LB control

Pressure compensated system characteristics

- Constant pressure and variable flow
- High pressure standby mode when flow is not needed
- System flow adjusts to meet system requirements
- Single pump can provide flow to multiple work functions
- Quick response to system flow and pressure requirements

Typical applications for pressure compensated systems

- Constant force cylinders (bailers, compactors, refuse trucks)
- On/off fan drives
- Drill rigs
- Sweepers
- Trenchers

**PVPC Adapter for
 External Pilot Oil Supply**

PVPC with check valve for open center PVP

PVPC with check valve is used in systems where it is necessary to operate the PVG 32 valve by means of the electrical remote control without pump flow.

When the external solenoid valve is opened, oil from the pressure side of the cylinder is fed via the PVPC through the pressure reducing valve to act as the pilot supply for the electrical actuators. This means that a load can be lowered by means of the remote control lever without starting the pump.

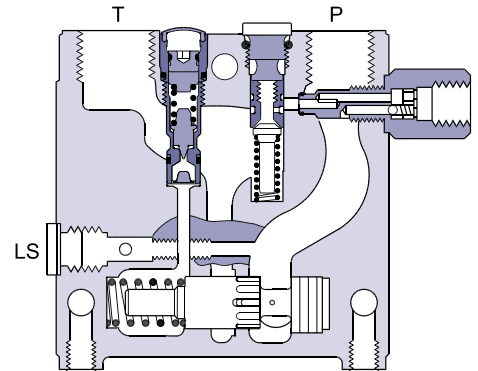

157-114.11

The built-in check valve prevents the oil from flowing via the pressure adjustment spool to tank.

With the pump functioning normally the external solenoid valve is closed to ensure that the load is not lowered due to the pilot supply oil flow requirement of approximately 1 l/min [0.25 US gal/min].

With closed center PVP the external pilot oil supply can be connected to the pressure gauge connection without the use of a PVPC plug.

Hydraulic diagram

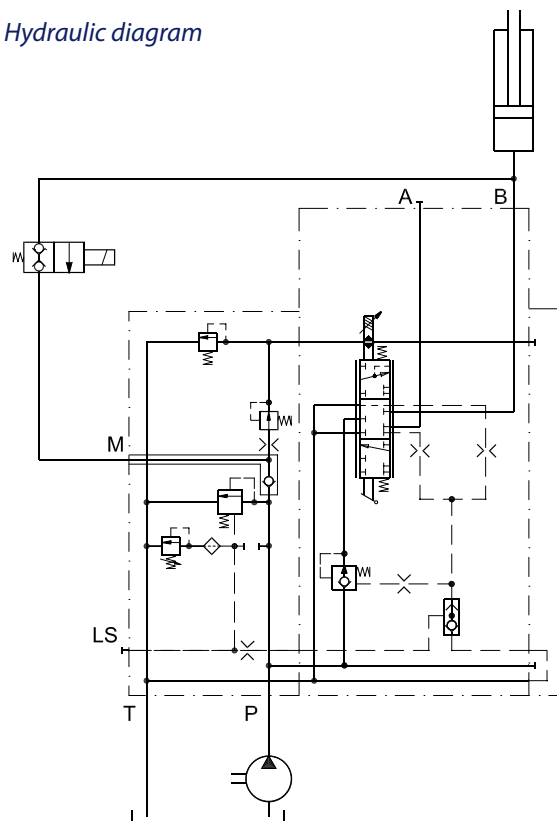

157-116.10

**PVPC Adapter for
 External Pilot Oil Supply
 (continued)**

PVPC without check valve for open or closed center PVP

PVPC without check valve is used in systems where it is necessary to supply the PVG 32 valve with oil from a manually operated emergency pump without directing oil flow to the pilot oil supply (oil consumption about 0.5 l/min) [0.13 US gal/min].

When the main pump is working normally, the oil is directed through the PVPC plug via the pressure reduction valve to the electrical actuators.

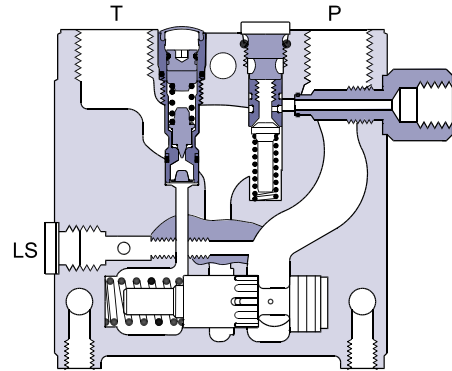

157-193.11

When the main pump flow fails, the external shuttle valve ensures that the oil flow from the manually operated emergency pump is used to pilot open the over center valve and lower the load. The load can only be lowered using the mechanical operating lever of the PVG 32 valve.

Hydraulic diagram

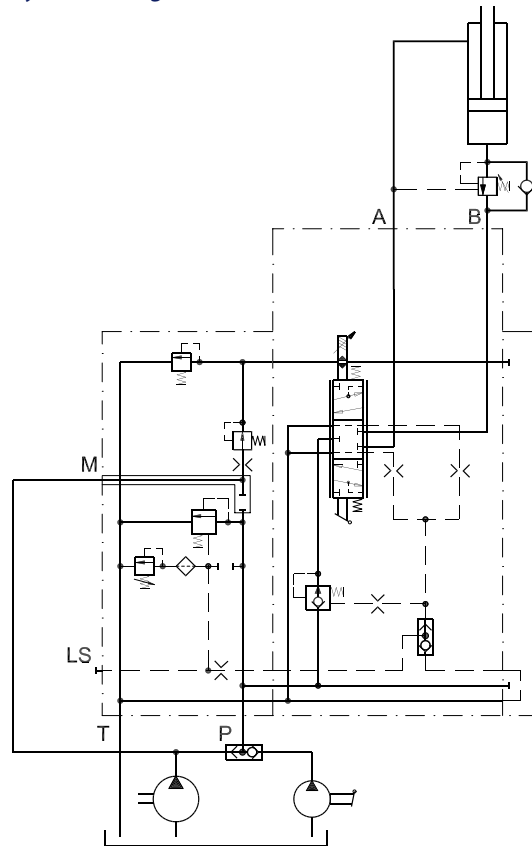

157-194.11

PVMR, Friction Detent

The friction detent PVMR allows the directional spool to be held in any position, resulting in infinitely variable, reversible, pressure compensated flow.

This can be sustained indefinitely without having to continue to hold the mechanical lever.

PVMR should only be used together with PVB basic modules with pressure compensator.

PVMR

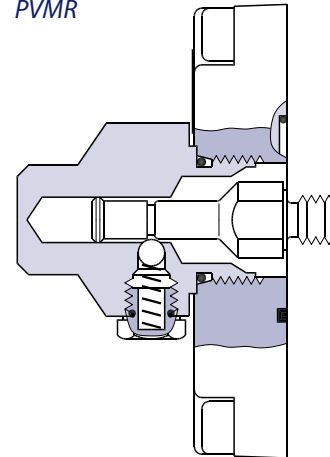

157-204.10

PVMF, Mechanical Float Position Lock

Allows the float spool to be held in the float position after release of the mechanical handle.

PVMF

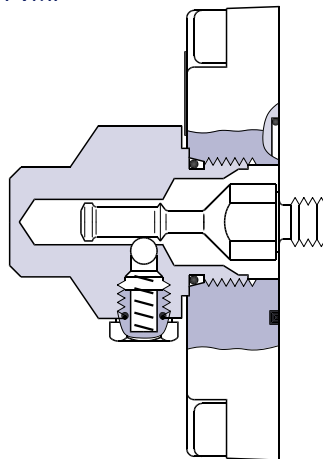

157-205.10

P → A → F
 (Standard assembly)

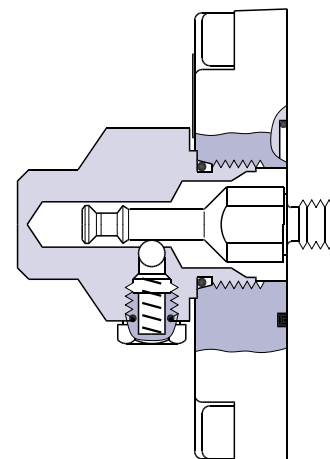

157-206.10

P → B → F
 (Standard assembly)

**PVBS, Main Spools for
Flow Control (Standard)**

When using standard flow control spools, the pump pressure is determined by the highest load pressure. This is done either via the pressure adjustment spool in open center PVP (fixed displacement pumps) or via the pump control (variable displacement pumps).

In this way the pump pressure will always correspond to the load pressure plus the stand-by pressure of the pressure adjustment spool or the pump control. This will normally give optimum and stable adjustment of the oil flow.

**PVBS, Main Spools
for Flow Control (with
Linear Characteristic)**

PVBS main spools with linear characteristic have less dead band than standard spools and a proportional ratio between control signal and oil flow in the range beyond the dead band. PVBS with linear characteristic must never be used together with PVEM electrical actuators.

The interaction between the small dead band of the spools and the hysteresis of the PVEM actuator of 20% involves a risk of building up a LS pressure in neutral position.

In a few systems load sensing pump pressure may result in unstable adjustment of the oil flow and a tendency towards system hunting.

This may be the case with working functions that have a large moment of inertia or over-center valves. In such systems main spools for pressure control can be advantageous.

**PVBS, Main Spools for
Pressure Control**

The spools are designed in such a way that the pump pressure is controlled by the spool travel. The main spool must be displaced until the pump pressure just exceeds the load pressure before the working function is applied. If the main spool is held in this position, the pump pressure will remain constant – even if the load pressure changes – giving a stable system.

The use of pressure control spools, however, also means that:

- the oil flow is load dependent
- the dead band is load dependent
- the pump pressure can exceed the load pressure by more than is usual
- the pressure drop across main spool varies (energy consumption)

Due to these factors it is recommended that pressure control spools are only used when it is known for certain that problems with stability will arise or already have arisen, and in applications where constant pressure is needed e.g. drill holding.

**PVG 32 Main Spool
 with Pressure Control
 (continued)**

Background

Instability in load sense control systems in certain applications with oscillations in the range of 1/2 - 2 Hz. can cause severe instability problems while trying to control functions in an application.

Critical applications are usually related to functions with an important inertia torque and/or functions with secondarily fitted pressure controlled components e.g. over-center valves.

Examples; a slewing function and main lifting/lowering function of a crane.

The problem usually manifests itself in prolonged oscillation phenomena (Fig. 1), in a relatively constant sequence of oscillations (Fig. 2) or in the worst case in an amplified sequence of oscillations (Fig. 3).

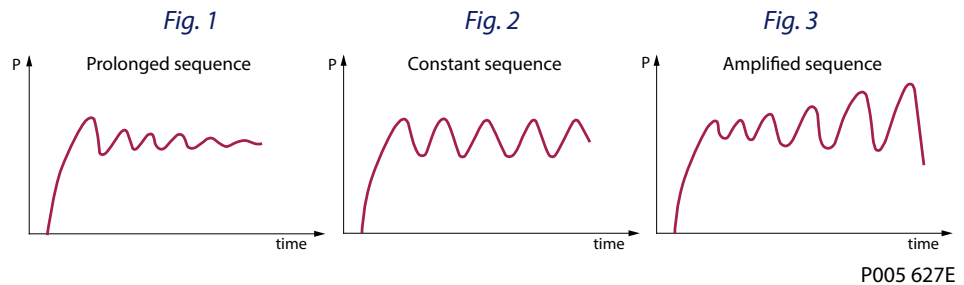

To control the oscillation phenomena the "pressure control spool" was developed and is a patented system which can minimize most of the oscillation issues described above.

Principle

The idea was to create a system operating independently of a constantly changing load pressure. Therefore, we changed the well-known LS principle (Fig. 4), so that compensated pump pressure is part of the LS system (Fig. 5) after the pressure compensator and before the metering range of the main spool. Upon actuation of the spool, it will be led via a fixed and a variable orifice.

The opening area of the variable orifice is at maximum at initial actuation and 0 at full stroke of the spool and then the pressure created between the two orifices is led into the LS system in the usual way.

**PVG 32 Main Spool with
Pressure Compensated
Control (continued)**

Fig. 4 Flow Controlled Spool

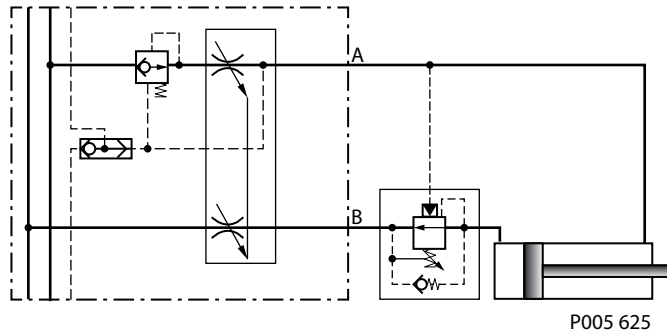
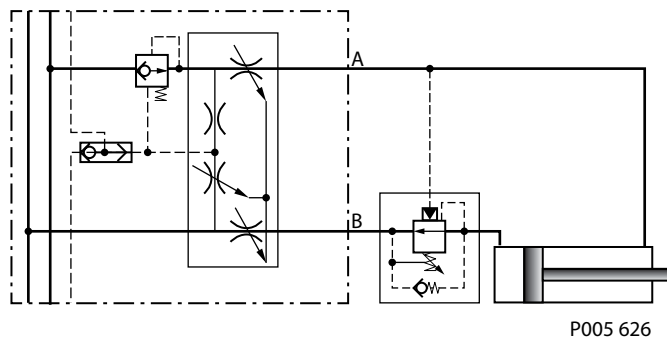

Fig. 5 Pressure Controlled Spool



In this way the pump pressure is built up depending on the spool travel, i.e. the spool will then have to be stroked to a position that the pump pressure is higher than the actual load pressure to make the oil flow from P to A/B.

When the load changes for a fixed spool position the flow to for the function will also change.

The pump pressure vs. the spool travel curve

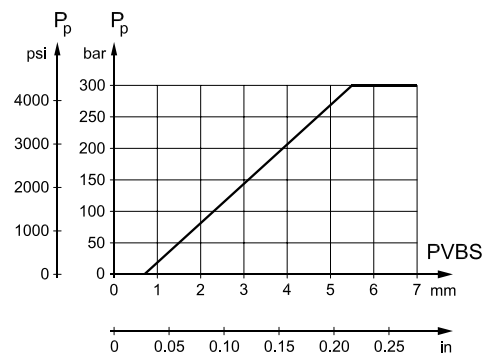

157-156.10

The valve section is now a load-dependent valve, but ensuring a constant pump pressure which is important in obtaining a stable function.

**PVG 32 Main Spool with
Pressure Compensated
Control (continued)**

Application

Pressure controlled spools should in principle only be used when you have stability issues. Typical applications on a crane:

- Lifting/lowering movement
- Slewing movement with cylinders
- For the main lifting/lowering function on a crane it is recommended to fit a "half" pressure control spool. This means that the spool is designed with a normal flow control on the lifting port and pressure control connected to the port where the pilot signal to the over-center valve is acting. You will thus maintain a load-independent lifting movement and achieve a stable but load-dependent lowering movement.
- As the load pressure on slewing movements is usually steady - irrespective of the crane being loaded or not - it will be advantageous to use a "full" pressure control spool for A and B port.

In both cases we recommend the use of a basic valve, PVB, with pressure compensator. The pressure compensator will ensure the individual load-independency between the basic valves.

It is further recommended to use the LS pressure relief valves as not only will they ensure individual pressure limitation but also make it possible to adjust the maximum oil flow to the function.

It is not recommended to use shock valves as pressure limiting valves in connection with pressure control spools.

Sizing

The size of "half" (e.g: P - A = flow control P - B pressure control) pressure control spools is determined on basis of max. flow demand on the lifting port. If e.g. a max. pressure compensated flow of 65 l/min for the lifting movement, you choose a 65 L/min spool (size D). The metering characteristic has then a given size. As it is often requested to limit the use of the crane boom for downward push/force mode and the LS pressure limitation can be used. It will appear from the characteristics enclosed what effect a pressure limitation, P_{LS} will have on max. flow on the lowering port.

The size for a "full" pressure control spool is determined on basis of known load pressure, P_{LS} max, and requested max. flow.

It will appear from the characteristics enclosed that if the load P_{LS} is low and the pump pressure, P_p , is high as a result of max. stroked spool you will get a large flow.

If P_{LS} is approaching P_{LS} max. the flow will be reduced and the dead band increased.

Max. oil flow can be reduced by approx. 50% without limiting max. pressure.

The reduction is made by limiting the spool travel from 7 mm to 5.5 mm.

Limitation

If a pressure controlled spool is chosen for stability reasons consideration should be made to features related to the pressure control principle.

Deadband will change according to the load conditions and the valve section will become load-dependent and that the pump pressure may exceed the load pressure. With all of the above in mind, a "pressure controlled spool" will minimize oscillation and obtain a stable function that can be controlled smooth and precise.

**PVPX, Electrical LS
 Unloading Valve**

PVPX is a solenoid LS unloading valve. PVPX is fitted into the pump side module enabling a connection to be made between the LS and the tank lines. Thus the LS signal can be relieved to tank by means of an electric signal.

For a PVP pump side module in open center version the relief to tank of the LS signal means that the pressure in the system is reduced to the sum of the tank port pressure plus the neutral flow pressure for the pump side module.

For a PVP pump side module in closed center version the relief to tank of the LS signal means that the pressure is reduced to the sum of the tank port pressure for the pump side module plus the stand-by pressure of the pump.

PVPX

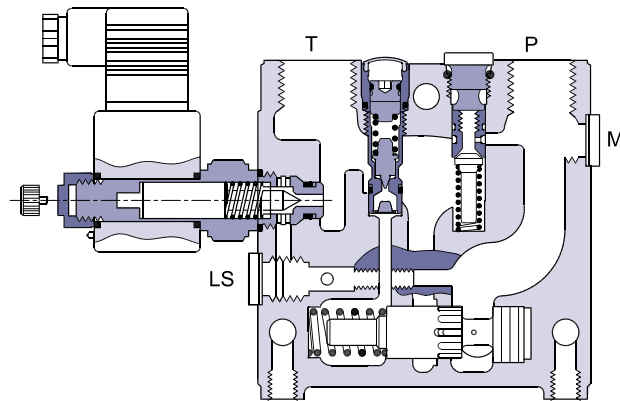

157-195.11

PVG 32

The characteristics in this catalog are typical measured values. During measuring a mineral based hydraulic oil with a viscosity of 21 mm²/s [102 SUS] at a temperature of 50 °C [122 °F] was used.

Technical data

Max. pressure	Port P continuous	350 bar ¹⁾	[5075 psi]
	Port P intermittent	400 bar ⁵⁾	[5800 psi]
	Port A/B continuous	350 bar	[5075 psi]
	Port A/B intermittent	420 bar ⁵⁾	[6090 psi]
	Port T, static/dynamic	25/40 bar	[365/580 psi]
Oil flow rated	Port P	140/230 l/min ^{3) 4)}	[37/61 US gal/min] ^{3) 4)}
	Port A/B, with press.comp.	100 l/min ²⁾	[26.4 US gal/min] ²⁾
	Port A/B without press.comp.	125 l/min	[33 US gal/min]
Spool travel, standard		± 7 mm	[± 0.28 in]
Spool travel, float position	Proportional range	± 4.8 mm	± 0.19 in]
	Float position	± 8 mm	[± 0.32 in]
Dead band, flow control spools	Standard	± 1.5 mm	[± 0.06 in]
	Linear characteristic	± 0.8 mm	[± 0.03 in]
Max. internal leakage at 100 bar [1450 psi] and 21 mm²/s [102 SUS]	A/B → T without shock valve	20 cm ³ /min	[1.85 in ³ /min]
	A/B → T with shock valve	25 cm ³ /min	[2.15 in ³ /min]
Oil temperature (inlet temperature)	Recommended temperature	30 → 60 °C	[86 → 140 °F]
	Min. temperature	-30 °C	[-22 °F]
	Max. temperature	+90 °C	[194 °F]
Ambient temperature		-30 → 60 °C	[-22 → 140 °F]
Oil viscosity	Operating range	12 - 75 mm ² /s	[65 - 347 SUS]
	Min. viscosity	4 mm ² /s	[39 SUS]
	Max. viscosity	460 mm ² /s	[2128 SUS]
Filtration <i>(See chapter Filtration)</i>	Max. contamination (ISO 4406)	23/19/16	23/19/16
Oil consumption in pilot oil pressure reduction valve		0.5 l/min	[0.13 US gal/min]

- 1) With PVS1 end plate. With PVS end plate max. 300 bar [4351 psi].
- 2) For 130 l/min contact Product Application Engineering Sauer-Danfoss.
- 3) In open circuit systems with short P-hoses/tubes, attention should be paid to pressure peaks at flows >100 l/min [26.4 US gal/min].
- 4) For system with mid inlet PVPVM.
- 5) Intermittent pressure at max. 250,000 cycles of full PVG life time cycles, with PVS1 end plate. The maximum intermittent pressure at max. 250,000 cycles stresses the need to confirm application duty cycle before proceeding with specification. For further information contact Product Application Engineering Sauer-Danfoss.

Rated Pressure

Product	Rated pressure
PVG 32 with PVS	300 bar [4351 psi]
PVG 32 with PVS1	350 bar [5076 psi]
PVG 32 with PVBZ	250 bar [3626 psi]
PVG 32 with HIC steel	350 bar [5076 psi]
PVG 32 with HIC aluminium	210 bar [3046 psi]
PVG 120/32 with PVS	300 bar [4351 psi]
PVG 120/32 with PVS1	350 bar [5076 psi]
PVG 100/32 with PVS	300 bar [4351 psi]
PVG 100/32 with PVS1	350 bar [5076 psi]

Maximum continuous P-port pressure.

PVH, Hydraulic Actuation

Technical data for PVH

Control range pressure	5 – 15 bar [75 – 220 psi]
Max. pilot pressure	30 bar [435 psi]
Max. pressure on port T*	10 bar [145 psi]

* The hydraulic remote control lever should be connected directly to tank.

PVM, Mechanical Actuation

Technical data for PVM

Spool displacement	Operating Torque N·m [lbf·in]				
	PVM + PVMD	PVM + PVE 1)	PVM + PVH	PVM + PVMR	PVM+PVMF
from neutral position	2.2 ±0.2 [19.5 ±1.8]	2.2 ±0.2 [19.5 ±1.8]	2.5 ±0.2 [22.1 ±1.8]	17 [3.8]	22 [5.0]
max. spool travel	2.8 ±0.2 [24.8 ±1.8]	2.8 ±0.2 [24.8 ±1.8]	6.9 ±0.2 [61.0 ±1.8]	–	–
into float position	–	–	–	–	60 [13.5]
away from float position	–	–	–	–	28 [6.3]
from any other position	–	–	–	8.5 [73.3]	–

Control lever position	No	2 x 6
	control lever	±19.5°
Control range	proportional	±13.4°
	float position	22.3°

For PVE please see the *PVE-Series 4 for PVG 32, PVG 100 and PVG 120 Technical Information, 520L0553*.

PVE Technical Data

Technical data for PVEO and PVEM

Supply voltage U_{DC}	rated	12 V DC	24 V DC
	range	11 V to 15 V	22 V to 30 V
	max. ripple	5%	
Current consumption at rated voltage		0.65 A @ 12 V	0.33 A @ 24 V
Signal voltage (PVEM)	neutral	0.5 x U _{DC}	
	A-port ↔ B-port	0.25 · U _{DC} to 0.75 · U _{DC}	
Signal current at rated voltage (PVEM)		0.25 mA	0.50 mA
Input impedance in relation to 0.5 · U_{DC}		12 KΩ	
Power consumption		8 W	

Reaction time for PVEO and PVEM

Supply voltage	Function		PVEO ON/OFF s	PVEO-R ON/OFF s	PVEM Prop. medium s
Disconnected by means of neutral switch	Reaction time from neutral position to max. spool travel	max.	0.235	0.410	0.700
		rated	0.180	0.350	0.450
		min.	0.120	0.250	0.230
Disconnected by means of neutral switch	Reaction time from max. spool travel to neutral position	max.	0.175	0.330	0.175
		rated	0.090	0.270	0.090
		min.	0.065	0.250	0.065
Constant voltage	Reaction time from neutral position to max. spool position	max.	-	-	0.700
		rated	-	-	0.450
		min.	-	-	0.230
Constant voltage	Reaction time from max. spool travel to neutral position	max.	-	-	0.700
		rated	-	-	0.450
		min.	-	-	0.230
Hysteresis *		rated	-	-	20%

* Hysteresis (control signal/spool travel) is indicated at rated voltage and f = 0.02 Hz for one cycle.
 (one cycle = neutral → full A → full B → neutral)

Technical data for PVEA, PVEH and PVES

PVEA, PVEH and PVES			
Supply voltage U_{DC}	rated	11 V to 32 V	
	range	11 V to 32 V	
	max. ripple	5%	
Current consumption at rated voltage		PVEH/PVES (PVEA)	0.57 (0.33) A @ 12 V 0.3 (0.17) A @ 24 V
Signal voltage	neutral	0.5 x U _{DC}	
	A-port ↔ B-port	0.25 · U _{DC} to 0.75 · U _{DC}	
Signal current at rated voltage		0.25 mA to 0.70 mA	
Input impedance in relation to 0.5 · U_{DC}		12 KΩ	
Input capacitor		100 ηF	
Power consumption		PVEH/PVES (PVEA)	7 (3.5) W
(PVEH/PVES)	Max. load		100 mA 60 mA
	Active	Reaction time at fault	500 ms (PVEA: 750 ms)
	Passive	Reaction time at fault	250 ms (PVEA: 750 ms)

**PVE Technical Data
 (continued)**

Reaction time for PVEA, PVEH and PVES

Supply voltage	Function		PVEA Prop. fine s	PVEH Prop. high s	PVES Prop. super s
Disconnected by means of neutral switch	Reaction time from neutral position to max. spool travel	max.	0.50	0.23	0.23
		rated	0.32	0.15	0.15
		min.	0.25	0.12	0.12
Disconnected by means of neutral switch	Reaction time from max. spool travel to neutral position	max.	0.55	0.175	0.175
		rated	0.40	0.09	0.09
		min.	0.30	0.065	0.065
Constant voltage	Reaction time from neutral position to max. spool travel	max.	0.50	0.20	0.20
		rated	0.32	0.12	0.12
		min.	0.25	0.05	0.05
Constant voltage	Reaction time from max. spool travel to neutral position	max.	0.25	0.10	0.10
		rated	0.20	0.09	0.09
		min.	0.15	0.065	0.065
Hysteresis*		rated	2%	4%	~ 0%

*Typical hysteresis characteristics for control signal vs spool travel of different PVE types**

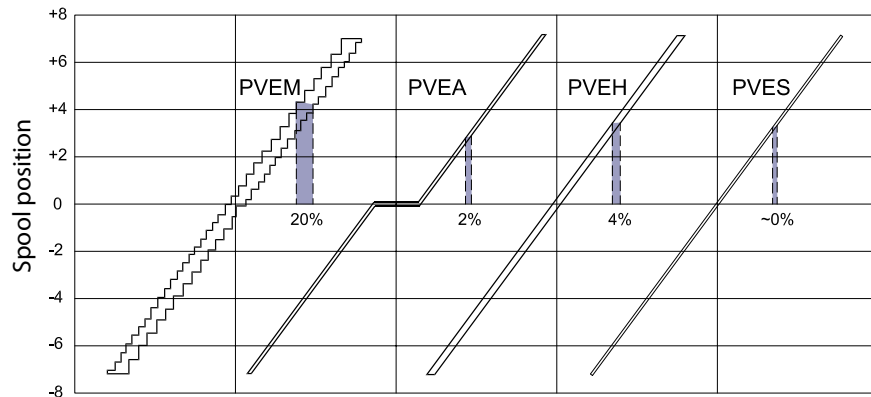

157-504.10

* Hysteresis (control signal/spool travel) is indicated at rated voltage and $f = 0.02$ Hz.
 (one cycle = neutral → full A → full B → neutral)

The following technical data are from typical test results. For the hydraulic system a mineral based hydraulic oil with a viscosity of $21 \text{ mm}^2/\text{s}$ [102 SUS] and a temperature of $50 \text{ }^\circ\text{C}$ [122 $^\circ\text{F}$] were used.

**PVE Technical Data
 (continued)**

Pilot oil consumption PVEA, PVEH, PVES, PVEO and PVEM

Function	PVEA Prop. fine	PVEH Prop. high	PVES Prop. super	PVEO ON/OFF	PVEM Prop. medium
Neutral without supply voltage	0	0	0.3 l/min [0.079 US gal/min]	0	0
Locked with supply voltage	0.4 l/min [0.106 US gal/min]	0.1 l/min [0.026 US gal/min]	0.1 l/min [0.026 US gal/min]	0.1 l/min [0.026 US gal/min]	0.1 l/min [0.026 US gal/min]
One actuation (neutral → max) with supply voltage	2 cm ³ [0,12 in ³]				
Continuous actuations with supply voltage	1 l/min [0.26 US gal/min]	0.7 l/min [0.185 US gal/min]	0.8 l/min [0.211 US gal/min]	0.7 l/min [0.185 US gal/min]	0.5 l/min [0.132 US gal/min]

Oil viscosity *	recommended range	12 - 75 mm ² /s	[65 - 347 SUS]
	minimum	4 mm ² /s	[39 SUS]
	maximum	460 mm ² /s	[2128 SUS]
Oil temperature	recommended range	30 - 60°C	[86 - 140°F]
	minimum	-30°C	[-22°F]
	maximum	90°C	[194°F]
Ambient temperature	recommended range	-30° → 60°C	[-22° → 140°F]
Filtering in the hydraulic system		Max. allowed degree of contamination: 23/19/16 (ISO 4406, 1999 version)	

* Max. start up viscosity 2500 mm²/s.

**PVPX, Electrical LS
 Unloading Valve**

Technical data for PVPX

Max. operating pressure		350 bar [5075 psi]	
Enclosure to IEC 529		IP65	
Max. pressure drop at an oil flow of 0.1 l/min [2.6 US gal/min]		2 bar [30 psi]	
Oil temperature (Inlet)	Recommended temperature	30°C to 60°C [86°F to 140°F]	
	Min. temperature	-30°C [-22°F]	
	Max. temperature	90°C [194°F]	
Max. coil surface temperature		155°C [311°F]	
Ambient temperature		-30°C to 60°C [-22°F to 140°F]	
Oil viscosity	Operating range	12 to 75 mm ² /s [65 to 347 SUS]	
	Min. viscosity	4 mm ² /s [39 SUS]	
	Max. viscosity	460 mm ² /s [2128 SUS]	
Response time for LS pressure relief		300 ms	
Rated voltage		12 V	24 V
Max. permissible deviation from rated supply voltage		± 10%	
Current consumption at rated voltage	at 22°C [72°F] coil temperature	1.55 A	0.78 A
	at 110°C [230°F] coil temperature	1 A	0.5 A
Power consumption	at 22°C [72°F] coil temperature	19 W	
	at 110°C [230°F] coil temperature	12 W	

Electrical control of PVG

Valve actuation with electrical actuators has been supported by Sauer-Danfoss for a long time. The actuation can be controlled directly by joystick, by a PLUS+1 controller or by a broad range of third part controllers.

The actuator controls the spool by building up pilot oil pressure on the end of the spool. For the PVE a pilot oil pressure between 10 and 15 bar is used. For the PVHC a pilot oil pressure between 20 and 25 bar is used.

PVG with PVE



F500113

Valve section with naming - standard mounted - seen from PVP

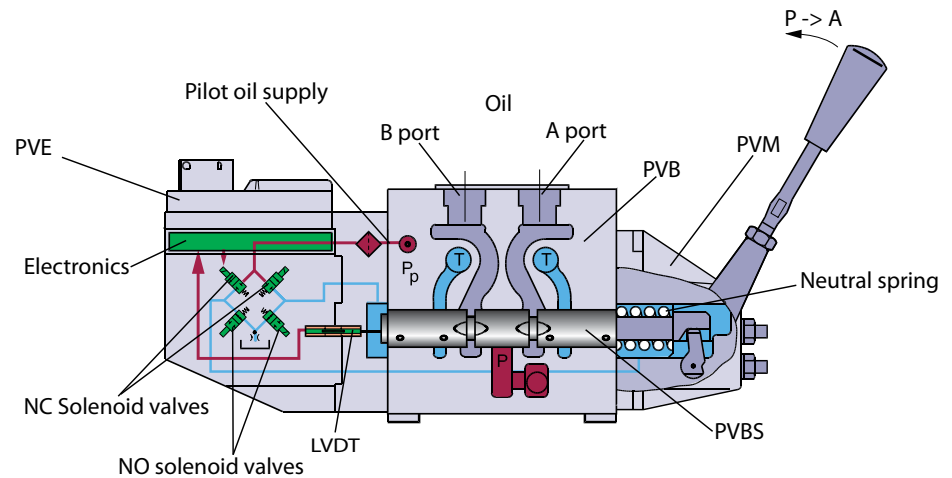

V310072.B

A detailed description of the variants is presented in the *PVE-Series 4 for PVG 32, PVG 100 and PVG 120 Technical Information, 520L0553*, covers all analogue PVE – PVEO, PVEH, PVES, PVEA, PVEM, PVEU, PVEP – and the current controlled PVHC.

Electrohydraulic Actuator – PVED-CC Series 4 Technical Information, 520L0665, covers the ISOBUS/SAE J1939 CAN controlled PVED-CC.

Electrohydraulic Actuator – PVED-CX Series 4 Technical Information, 11070179, covers the IEC61508 SIL2 certified CANopen controlled PVED-CX.

Electrical control of PVG (continued)

PVE characteristic – control by voltage

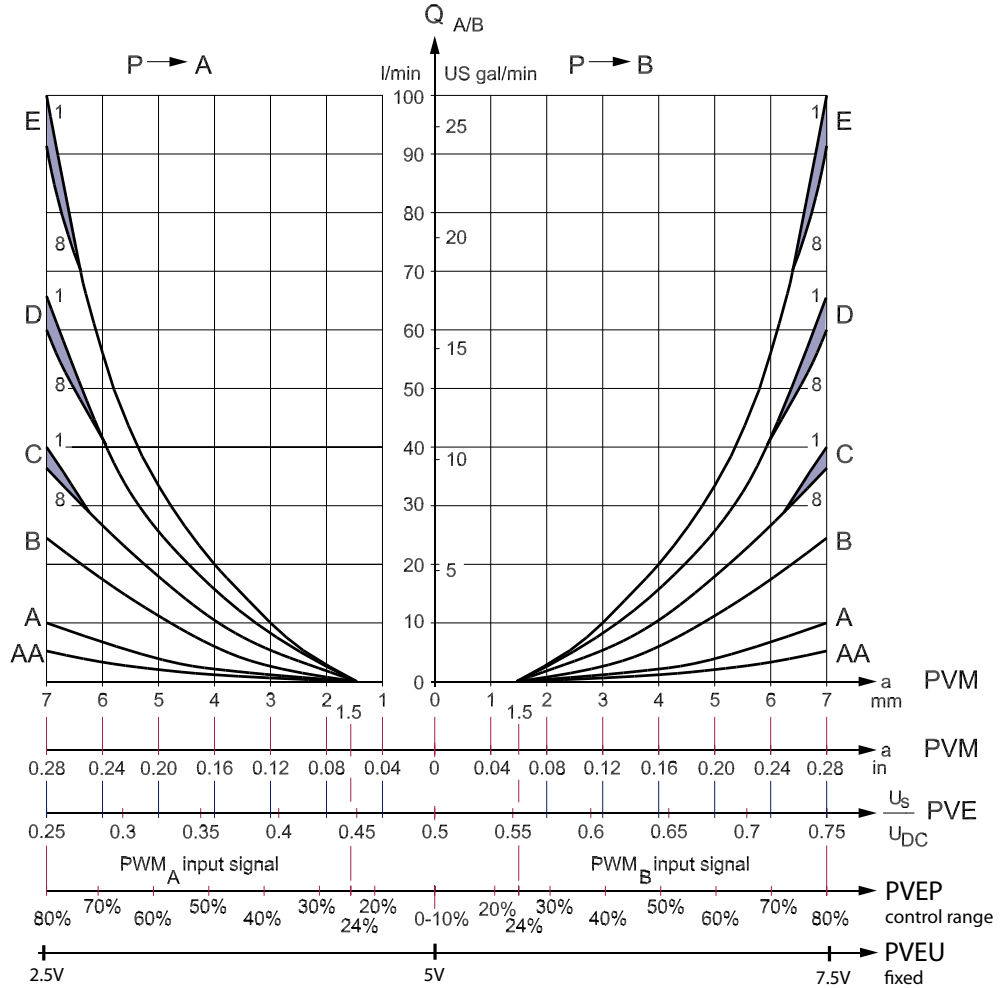

Closed loop control

The PVE variants PVEA/H/M/S/U/P and the PVED-CC/-CX has a closed loop control supported by a spool position sensor that ensures integrity towards flow forces and oil viscosity.

*Hysteresis for PVE variants**

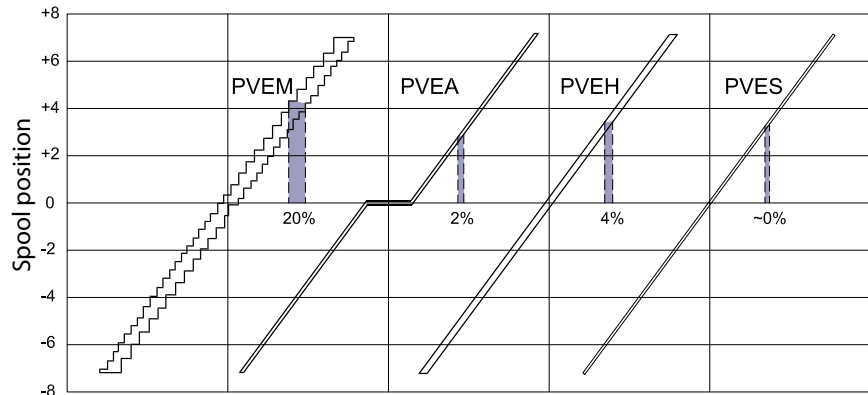

157-504.10

Hysteresis (Control signal /spool travel) is indicated at rated voltage and $f = 0.02$ Hz for one cycle (one cycle = neutral → full A → full B → neutral).

The values are typical test data for exact ranges, see *PVE Technical Information*, **520L0553**.

- PVEU is available with PVEH and PVES hysteresis
- PVEP, PVED-CC and PVED-CX are available with PVES hysteresis

The standard PVE's are proportional activated actuator except PVEO which is on/off. The PVE's have fault-monitoring.

Fault monitoring overview

Type	Fault monitoring	Delay before error out	Error mode	Error output status	Fault output on PVE ¹⁾	LED light	Memory (reset needed)
PVEO PVEM	No fault monitoring	–	–	–	–	–	–
PVEA PVEH PVEP PVES PVEU	Active	500 ms (PVEA: 750 ms)	No fault	Low	< 2 V	Green	–
			Input signal faults	High	$\sim U_{DC}$	Flashing red	Yes
			Transducer (LVDT) Close loop fault			Constant red	
	Passive	250 ms (PVEA: 750 ms)	No fault	Low	< 2 V	Green	–
			Input signal faults	High	$\sim U_{DC}$	Flashing red	No
			Transducer (LVDT) Close loop fault			Constant red	
PVE Float six pin	Active	500 ms	Float not active	High	$\sim U_D$	Constant red	Yes
		750 ms	Float still active				

1) Measured between fault output pin and ground.

PVEO

The PVEO is an on/off activated actuator. The PVEO has not fault-monitoring.

Variants:

- PVEO-R with a ramp delayed actuation
- PVEO-DI with direction indication feedback
- Anodized aluminum block
- ATEX certified

Power supply:

- 12V
- 24V

Connectors:

- Deutsch
- AMP
- DIN/Hirshmann

AMP version of PVEO/PVEO-R

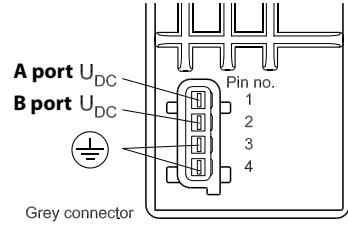

157-498.12

Hirschmann/DIN version of PVEO / PVEO-R

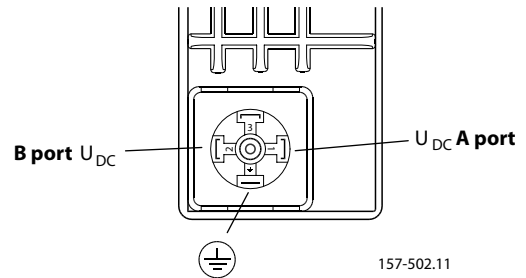

157-502.11

Deutsch version of PVEO

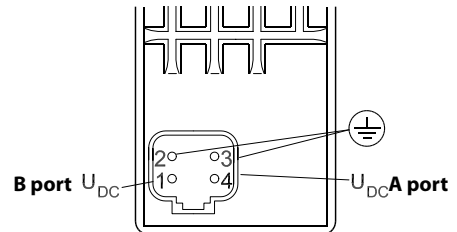

157-760.13

PVEM

The PVEM is a proportional activated actuator. The PVEM has not fault-monitoring.

Variants:

- PVEM -R with a ramp delayed actuation
- PVEM for float in B-direction and max flow B at 4.8mm

Power supply:

- 12V
- 24V

Connectors:

- DIN/Hirshmann

Hirschmann/DIN version of PVEO / PVEO-R

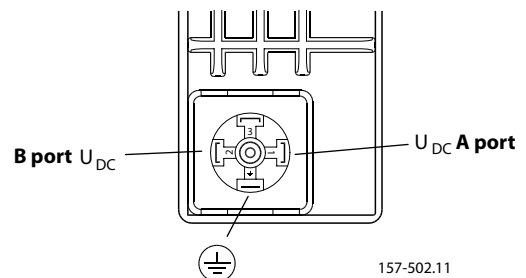

157-502.11

PVEA/H/S/U

Variants:

- -F for float in B-direction and max flow B at 4.8 mm
- -F for float in A-direction and max flow A at 5.5 mm
- PVES-SP with spool position feedback
- Anodized aluminum block
- ATEX certified

Power supply:

- 11-32V

Connectors:

- Deutsch
- AMP
- DIN/Hirschmann

AMP version PVEA/PVEH/PVES/PVEU/PVEH-Float A

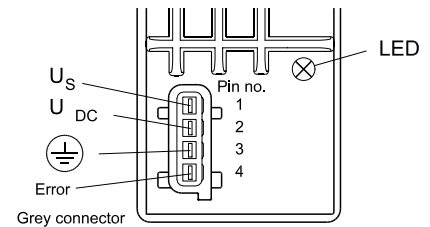

157-500.10

*Hirschmann/DIN version PVEH/PVEM/
 PVES/PVEH float B/PVEM float B*

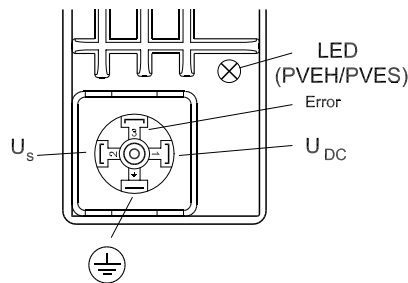

*Deutsch version PVEA/PVEH/PVES/PVEU/
 PVEH-Float B*

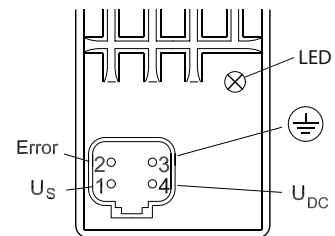

157-759.11

PVEP

The PVEP is controlled with separate PWM control signals for A and B direction. The PVEP has hysteresis and fault monitoring like the PVES.

Power supply:

- 11-32V

Connectors:

- Deutsch

Deutsch version PVEP

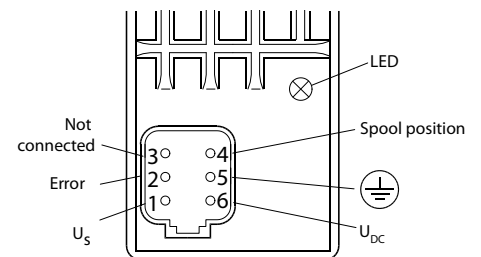

PVED-CC and PVED-CX

The CAN controlled PVE embedded microcontrollers support the same high spool controllability as the PVES and additionally has high quality feedbacks, safety monitoring and detailed diagnostics.

PVED has digital communication, that allows a wide range of feedback, setpoint and highly customized settings. CAN-Bus serial communication makes wiring much easier. Only one cable per PVG group.

Power supply:

- 11-32V

Connectors:

- Deutsch
- AMP (PVED-CX only AMP)

PVE with Deutsch connector incl. female connector

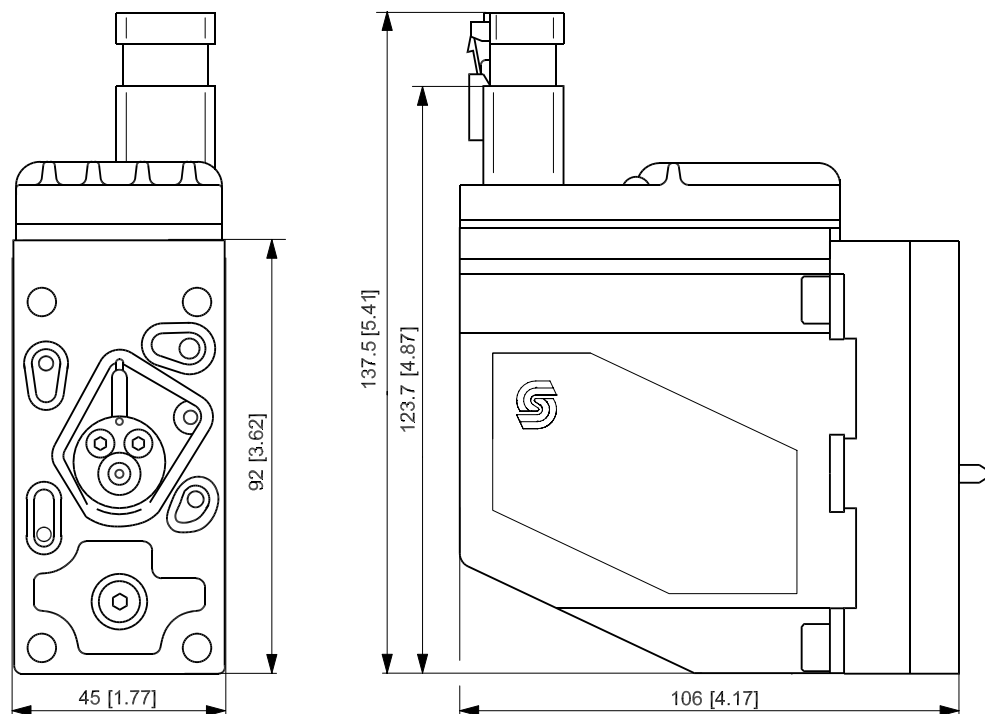

For more information on PVED please see the *Electrohydraulic Actuator - PVED-CC Series 4 Technical Information, 520L0665*.

PVHC

The PVHC is controlled with separate PWM control signals for A and B direction. The PVHC has not fault-monitoring nor closed loop spool control.

Spool stroke vs current

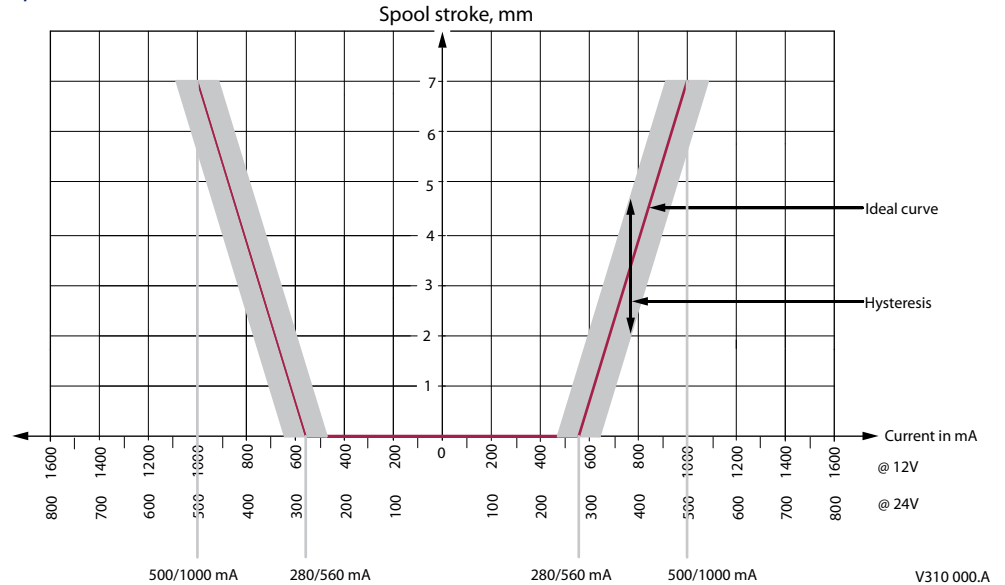

The ideal curve is determined by the main spool neutral spring. The hysteresis is affected by viscosity, friction, flow forces, dither frequency and modulation frequency.

Power supply:

- 12V
- 24V

Connectors:

- Deutsch
- AMP

PVP, Pump Side Modules

Symbol	Description	Code number
<p>157-24.10</p>	Open center pump side module for pumps with fixed displacement.	P = G 1/2 T = G 3/4 157B5000
	For purely mechanically actuated valve groups	P = 7/8-14 T = 1 1/16-12 157B5200
		P, T = G 3/4 157B5100
		P, T = 1 1/16-12 157B5300
<p>157-23.10</p>	Closed center pump side module for pumps with variable displacement.	P = G 1/2 T = G 3/4 157B5001
	For purely mechanically actuated valve groups	P = 7/8-14 T = 1 1/16-12 157B5201
		P, T = G 3/4 157B5101
		P, T = 1 1/16-12 157B5301
<p>157-22.10</p>	Open center pump side module for pumps with fixed displacement.	P = G 1/2 T = G 3/4 157B5010
	With pilot oil supply for electrically actuated valves	P = 7/8-14 T = 1 1/16-12 157B5210
		P, T = G 3/4 157B5110
		P, T = 1 1/16-12 157B5310
<p>157-21.10</p>	Closed center pump side module pumps with variable displacement.	P = G 1/2 T = G 3/4 157B5011
	With pilot oil supply for electrically actuated valves	P = 7/8-14 T = 1 1/16-12 157B5211
		P, T = G 3/4 157B5111
		P, T = 1 1/16-12 157B5311
<p>157-153.11</p>	Open center pump side module for pumps with fixed displacement.	P = G 1/2 T = G 3/4 157B5012
	With pilot oil supply for electrically actuated valves	P = 7/8-14 T = 1 1/16-12 157B5212
	Connection for electrical LS unloading valve, PVPX (not incl)	P, T = G 3/4 157B5112
		P, T = 1 1/16-12 157B5312
<p>157-154.10</p>	Closed center pump side module pumps with variable displacement	P = G 1/2 T = G 3/4 157B5013
	With pilot oil supply	P = 7/8-14 T = 1 1/16-12 157B5213
	Connection for electrical LS unloading valve, PVPX (not incl)	P, T = G 3/4 157B5113
		P, T = 1 1/16-12 157B5313

Connections:

P = G 1/2 in; 14 mm deep or G 3/4 in; 16 mm deep / **LS, M** = G 1/4 in; 12 mm deep / **T** = G 3/4 in; 16 mm deep.
P = 7/8-14; 0.65 in deep or 1 1/16-12; 0.75 in deep / **LS, M** = 1/2-20; 0.47 in deep / **T** = 1 1/16-12; 0.75 in deep.

PVP, Pump Side Modules

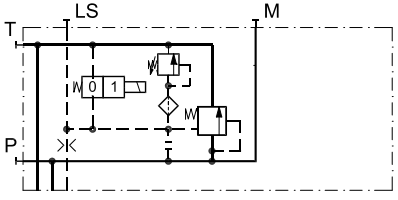
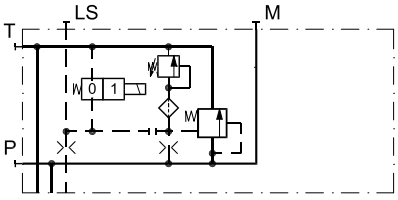
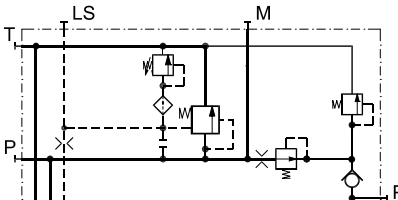
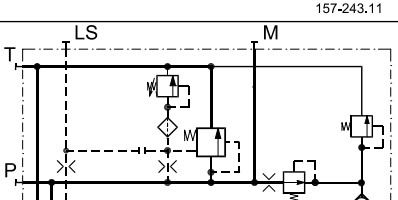
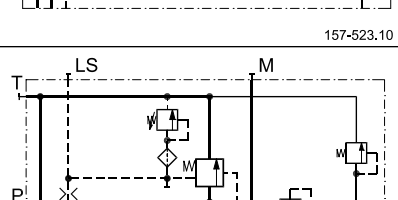
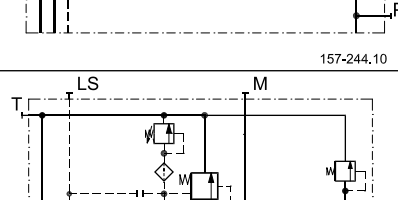
Symbol	Description	Code number
 <p>157-294.10</p>	<p>Open center pump side module for pumps with fixed displacement.</p> <p>For mechanical actuated valves.</p> <p>Connection for LS unloading valve, PVPX (not incl)</p> <p style="text-align: right;">P, T = G 3/4</p>	157B5102
 <p>157-295.10</p>	<p>Closed center pump side module for pumps with variable displacement.</p> <p>For mechanical actuated valves.</p> <p>Connection for LS unloading valve, PVPX (not incl)</p> <p style="text-align: right;">P, T = G 3/4</p>	157B5103
 <p>157-243.11</p>	<p>Open center pump side module for pumps with fixed displacement.</p> <p>With pilot oil supply for electrical actuation and connection for pilot oil pressure Incl. check valve</p> <p style="text-align: right;">P, T = G 3/4</p>	157B5180
 <p>157-523.10</p>	<p>Closed center pump side module for pumps with variable displacement.</p> <p>With pilot oil supply for electrical actuation and connection for pilot oil pressure Incl. check valve</p> <p style="text-align: right;">P, T = G 3/4</p>	157B5181
 <p>157-244.10</p>	<p>Open center pump side module for pumps with fixed displacement.</p> <p>With pilot oil supply for hydraulic actuation and connection for pilot oil pressure</p> <p style="text-align: right;">P, T = G 3/4</p>	157B5190
 <p>157-245.10</p>	<p>Closed center pump side module pumps with variable displacement</p> <p>With pilot oil supply for hydraulic actuation and connection for pilot oil pressure</p> <p style="text-align: right;">P, T = G 3/4</p>	157B5191

Connections:

P, T = G 3/4 in; 16 mm deep / **LS, M** = G 1/4 in; 12 mm deep
P, T = 1 1/16-12; 0.75 in deep / **LS, M** = 1/2-20; 0.47 in deep.

PVB, Basic Modules – Without Adjustable LS_{A/B} Pressure Limiting Valves

Symbol	Description	Code number	
		No facilities for shock valves A/B	Facilities for shock valves A/B
<p>157-19.10</p>	<p>Without load drop check valve and pressure compensator.</p> <p>Can be used where load holding valves prevent oil from flowing back through channel P.</p>	<p>G ½ 14 mm deep</p>	<p>157B6000</p> <p>157B6030</p>
	<p>7/8–14 0.65 in deep</p>	<p>157B6400</p> <p>157B6430</p>	
<p>157-20.10</p>	<p>Load drop check valve.</p>	<p>G ½ 14 mm deep</p>	<p>157B6100</p> <p>157B6130</p>
	<p>7/8–14 0.65 in deep</p>	<p>157B6500</p> <p>157B6530</p>	
<p>157-196.10</p>	<p>Load drop check valve.</p> <p>LS_{A/B} shuttle valve.</p> <p>To be used with float position spools.</p>	<p>G ½ 14 mm deep</p>	<p>—</p> <p>157B6136</p>
	<p>7/8–14 0.65 in deep</p>	<p>—</p> <p>157B6536</p>	
<p>157-16.10</p>	<p>Non-damped compensator valve</p>	<p>G ½ 14 mm deep</p>	<p>157B6200</p> <p>157B6230</p>
	<p>7/8–14 0.65 in deep</p>	<p>157B6600</p> <p>157B6630</p>	

PVB, Basic Modules - Without Adjustable $LS_{A/B}$ Pressure Limiting Valves

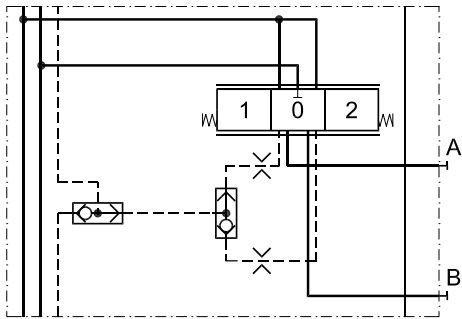
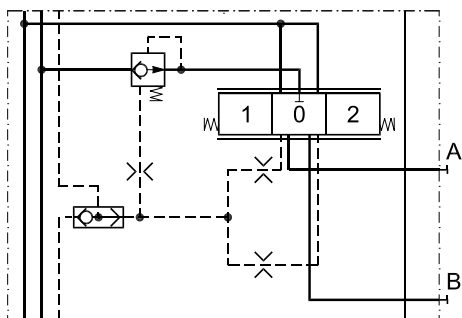
Symbol	Description	Code number	
		No facilities for shock valves A/B	Facilities for shock valves A/B
 <p>V310411.A</p>	Without compensator valve $G \frac{1}{2}$ 14 mm deep	—	11071832
	$LS_{A/B}$ shuttle valve $\frac{7}{8}$ -14 0.65 in deep	—	—
 <p>157-16.10</p>	With damped compensator valve $G \frac{1}{2}$ 14 mm deep	157B6206	157B6236
	$\frac{7}{8}$ -14 0.65 in deep	11036629	11036630

PVB, Basic Modules - With Adjustable LS_{A/B} Pressure Limiting Valves

Symbol	Description	Code number		
		No facilities for shock valves A/B	Facilities for shock valves A/B	
<p>157-198.10</p>	With non-damped compensator valve Adjustable LS _{A/B} pressure limiting valves	G ½ 14 mm deep	157B6203	157B6233
	External LS connection port A/B. Also used for float position spools	7/8-14 0.65 in deep	157B6603	157B6633
<p>157-17.10</p>	Damped compensator valve Adjustable LS _{A/B} pressure limiting valves	G ½ 14 mm deep	157B6208	157B6238
	External LS connection port A/B	7/8-14 0.65 in deep	-	11036631

PVLA, Suction Valve (fitted in PVB)

Symbol	Description	Code number
<p>157-15.10</p>	Suction valve for port A and/or B.	157B2001
<p>157-223.10</p>	Plug for connecting the nonactive port to tank, when using a single acting spool.	157B2002

PVLP, Shock and Suction Valve (Fitted in PVB)

Symbol / Description
<p>157-18.10</p>
Shock and suction valve for port A and/or B. (Not adjustable). Lifetime 200.000 actuations.

Code no.	157B2032	157B2050	157B2063	157B2080	157B2100	157B2125	157B2140	157B2150	157B2160	157B2175	157B2190	
Settings	bar	32	50	63	80	100	125	140	150	160	175	190
	[psi]	460	725	914	1160	1450	1813	2031	2175	2320	2538	2755
Code no.	157B2210	157B2230	157B2240	157B2250	157B2265	157B2280	157B2300	157B2320	157B2350	157B2380	157B2400	
Settings	bar	210	230	240	250	265	280	300	320	350	400	
	[psi]	3045	3335	3480	3625	3845	4061	4351	4641	5075	5801	

PVM, Mechanical Actuation

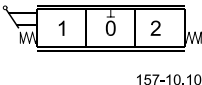
Symbol	Description	Code number	
		with stop screws	w/o stop screws
 157-10.10	PVM, Standard, spring centered Individual oil flow adjustment to ports A and B	157B3171	157B3191
	Without actuation lever and base. Shaft for mounting of actuation lever	157B3173	157B3193
	PVM, as standard, without actuation lever. With base for mounting of actuation lever	157B3174	157B3194
	PVM, Standard, spring. Individual oil flow adjustment to ports A and B. (Anodized)	157B3184	-

PVMD, Cover for Mechanical Actuation

Symbol	Description	Material	Code No.	Anodized
—	PVMD, Cover for purely mechanically operated valve	aluminium	157B0001	no
		aluminium	157B0009	yes
		cast iron	157B0021	no

PVMR, Friction Detent

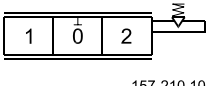
Symbol	Description	Material	Code number	Anodized
 157-210.10	PVMR, Friction detent	aluminium	157B0004	no
		aluminium	157B0012	yes
		cast iron	157B0024	-

PVMF, Mechanical Float Position

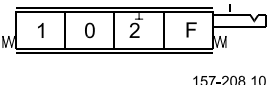
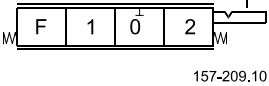
Symbol	Description	Material	Code number	Anodized
 157-208.10	PVMF, Mechanical float position lock	aluminium	157B0005	no
 157-209.10				

PVH, Hydraulic Actuation

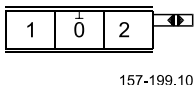
Symbol	Description	Material	Code number	Anodized
 157-199.10	PVH, Cover for Hydraulic actuation PVH 9/16-18 UNF	aluminium	157B0007	no
		aluminium	157B0010	yes
		cast iron	157B0014	no
	PVH, Cover for Hydraulic actuation PVH G1/4	aluminium	157B0008	no
		aluminium	157B0011	yes
		cast iron	157B0016	no

PVS, End Plate

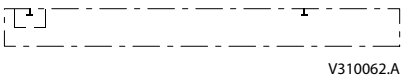
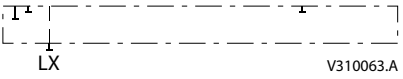
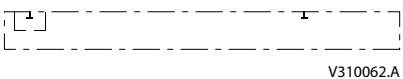
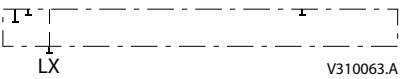
Symbol	Description	Mounting threads	Code number
	PVS, without active elements. No connections	BSP	157B2000
		SAE	157B2020
	PVS, without active elements. Max. intermittent LX pressure 250 bar [3625 psi]	G 1/8 10 mm deep BSP	157B2011
		3/8 in - 24; 0,39 in deep SAE	157B2021
	PVSI, without active elements Without connections.	BSP	157B2014
		SAE	157B2004
	PVSI, without active elements LX connections. Max. intermittent LX pressure: 350 bar [5075 psi]	G 1/4 10 mm deep BSP	157B2015
		1/2 in - 20; 0,47 in deep SAE	157B2005

For mounting threads please see chapter "dimensions".

PVAS, Assembly Kit

Code no, 157B...	0	1	2	3	4	5	6	7	8	9	10	11	12
PVB's	8000	8001	8002	8003	8004	8005	8006	8007	8008	8009	8010	8061	8062
PVB + PVPVM	-	8021	8022	8023	8024	8025	8026	8027	8028	8029	8030	8081	8082
Weight kg [lb]	0.1[0.2]	0.15 [0.3]	0.25 [0.6]	0.30 [0.7]	0.40 [0.9]	0.45 [1.0]	0.50 [1.1]	0.60 [1.3]	0.65 [1.4]	0.70 [1.6]	0.80 [1.7]	0.85 [1.8]	0.9 [2.0]

PVPX, Electrical LS Unloaded Valve

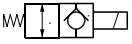
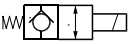
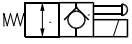
Symbol	Description		Code number
 157-150.10	PVPX, Normally open: LS pressure relieved with no signal to PVPX	12 V	157B4236
		24 V	157B4238
 157-151.10	PVPX, Normally closed: LS pressure relieved with no signal to PVPX	12 V	157B4246
		24 V	157B4248
 157-152.10	PVPX, Normally open with manual override: LS pressure relieved with no signal to PVPX Manual override DE-selects LS-pump	12 V	157B4256
		24 V	157B4258
-	Plug		157B5601

PVPC, Plug for External Pilot Oil Supply

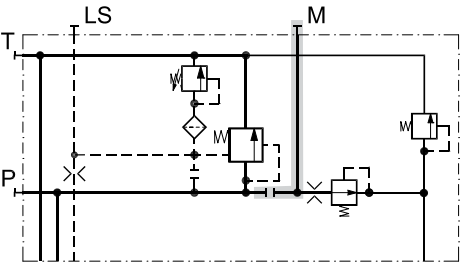
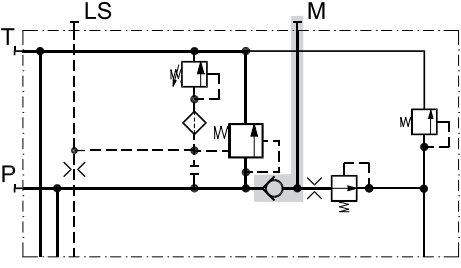
Symbol	Description		Code number
 157-191.10	PVP, Plug without check valve for open or closed center	G 1/2, 12 mm deep	157B5400
		1/2 in - 20; 0.47 in deep	-
 157-192.10	PVP, Plug with check valve for open center	G 1/2, 12 mm deep	157B5600
		1/2 in - 20; 0.47 in deep	157B5700

General

The characteristics in this catalog are typical measured values. During measuring a mineral based hydraulic oil with a viscosity of 21 mm²/s [102 SUS] at a temperature of 50°C [122°F] was used.

PVP, Pump Side Module

Pressure relief valve characteristic in PVP

The pressure relief valve is set at an oil flow of 15 l/min [4.0 US gal/min].
 Setting range:

- 30 to 350 bar [435 to 5075 psi] with PVS1 end plate
- 30 to 300 bar [435 to 4351 psi] with PVS end plate

Pressure relief valve characteristic

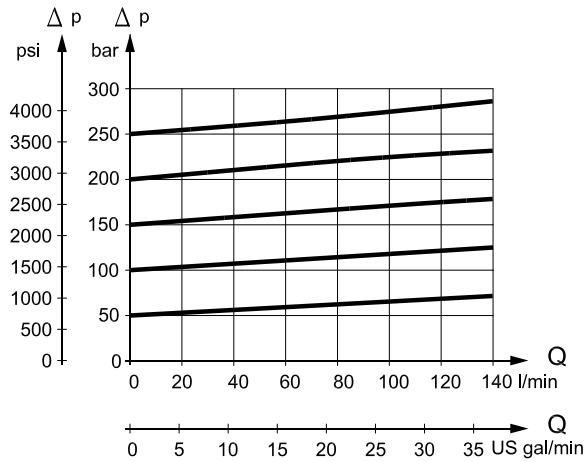

157-83.10

Neutral by-pass pressure drop charastic (open center)

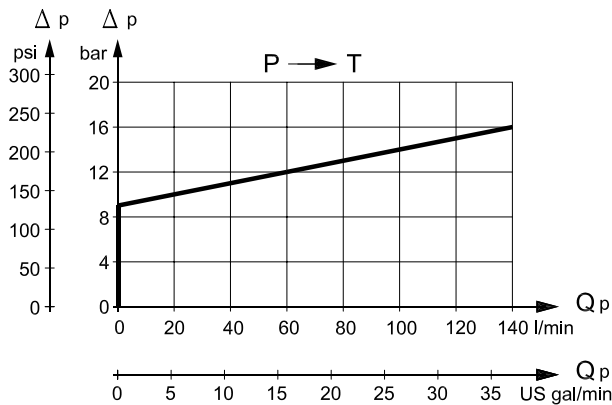

157-184.10

PVB

Oil flow characteristics

The oil flow for the individual spool depends on:

- type of basic module (with/without compensation)
- type of pump (fixed or variable displacement).

Pressure-compensated PVB, open or closed center PVP

The oil flow is dependent on the supplied pump oil flow. The characteristics are plotted for a pump oil flow, Q_p , corresponding to the rated max. spool oil flow, Q_N . Increasing the pump oil flow to $1,4 \times Q_N$ will give the same oil flow on the eighth as on the first basic module.

Please note, the letters AA, A, B, etc. denote spool types. The characteristic below is shown for spool travel in both directions. All other characteristics are shown for spool travel in one direction only.

Progressive oil flow characteristic depending on spool type

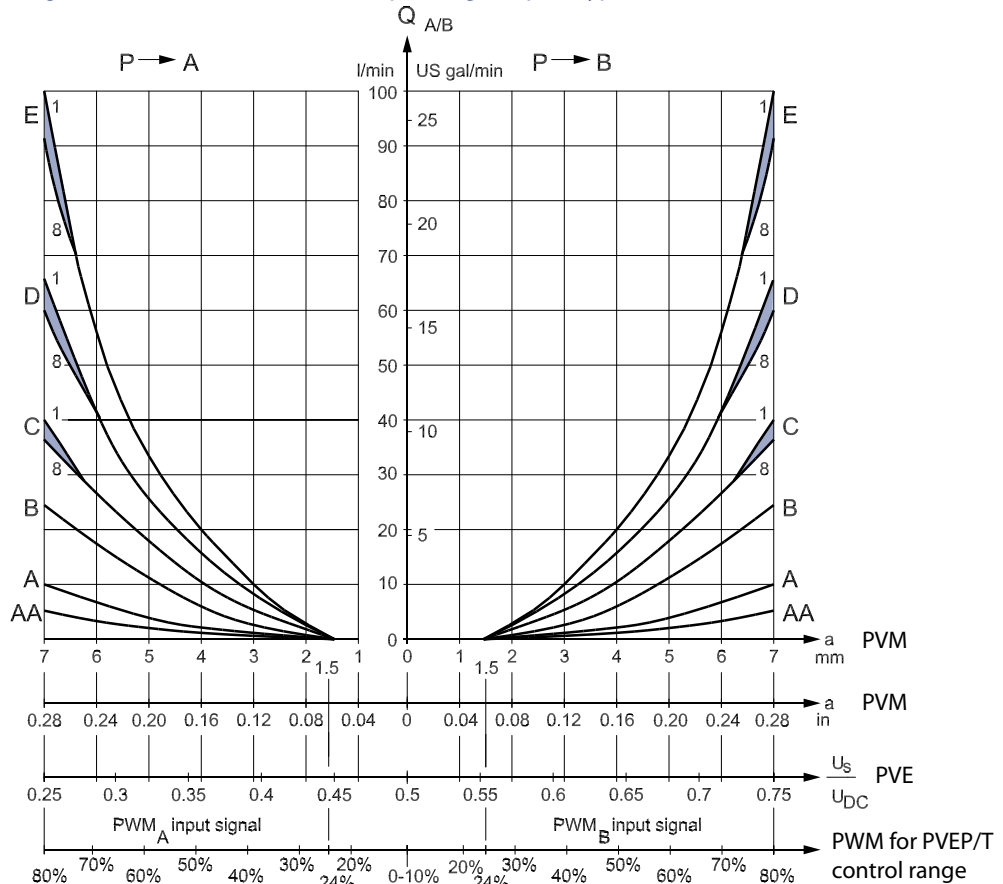

157-61.im

- U_s = Signal voltage
- U_{DC} = Supply voltage
- 1 = First PVB after PVP
- 8 = Eighth PVB after PVP

PVB, Basic Modules

Linear oil flow depending on spool type

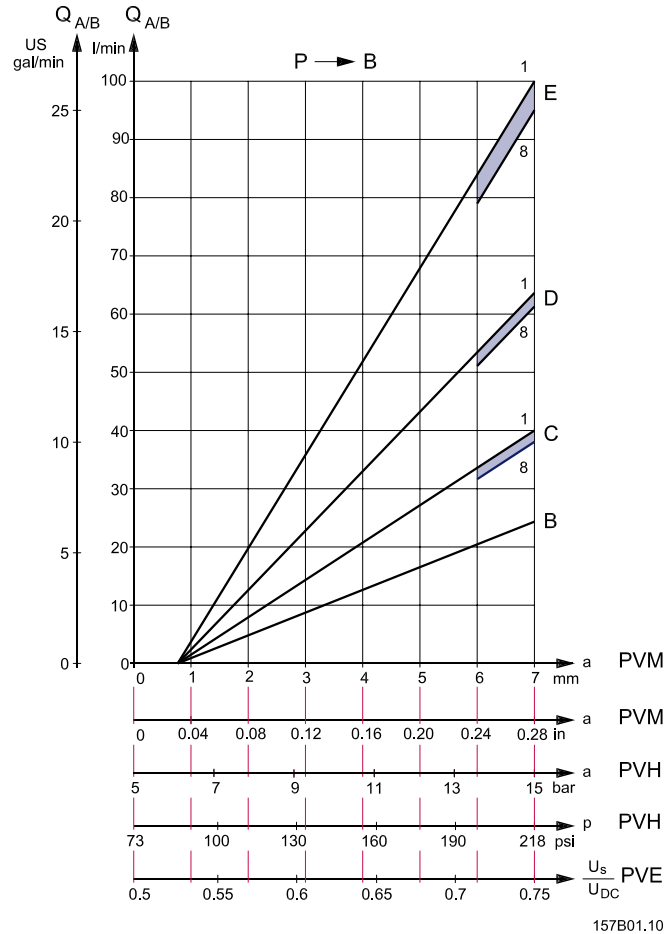

U_s = Signal voltage
 U_{DC} = Supply voltage
 1 = First PVB after PVP
 8 = Eighth PVB after PVP

157B01.10

**PVB, Basic Modules
 (continued)**

PVB without pressure compensation, open center PVP

Oil flow as a function of spool travel

The spool flow is dependent on the supplied oil flow, Q_p .

The characteristics apply to supply oil flow of 130 l/min [34.3 US gal/min] with the actuation of one basic module and the supply flow level.

If several basic modules are activated at the same time, the characteristic depends on the load pressure of the actuated basic modules.

Oil flow as a function of spool travel characteristic

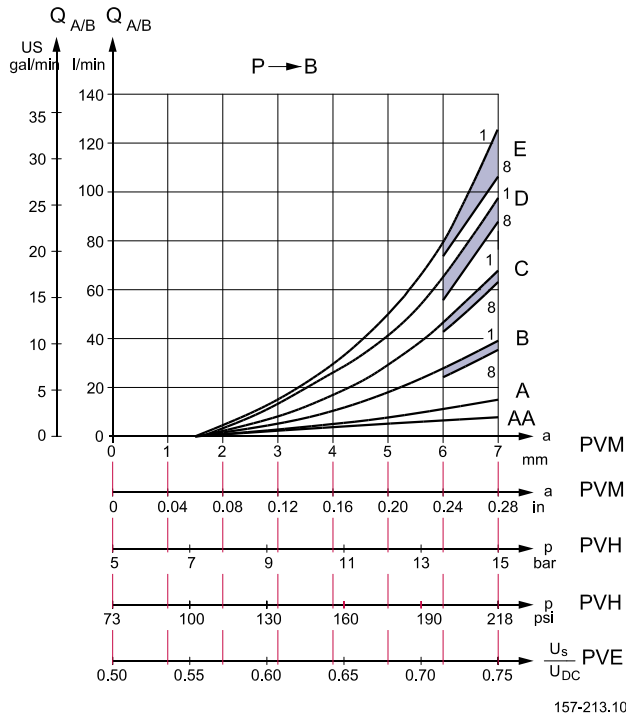

**PVB, Basic Module
 (continued)**

Oil flow $Q_{A/B}$ as a function of supplied pump oil flow (Q_p)

The pressure drop of any oil flowing back to tank ($Q_p - Q_{A/B}$) is read on the curve for neutral flow pressure in PVP.

Characteristic for fully displaced flow control spools

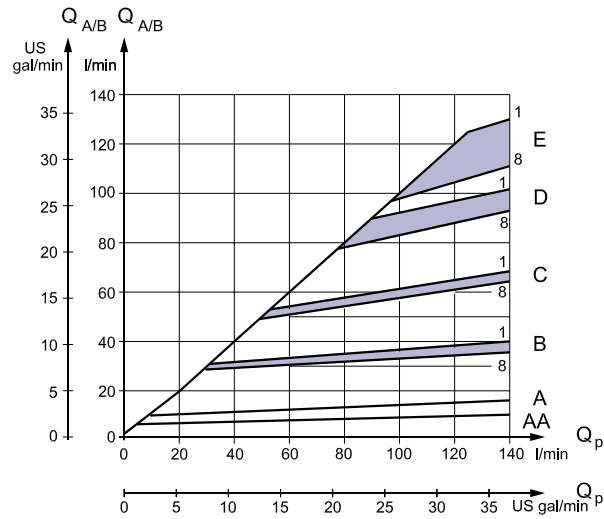

157-212.10

**PVB, Basic Module
 (continued)**

PVB without pressure compensation, closed center PVP

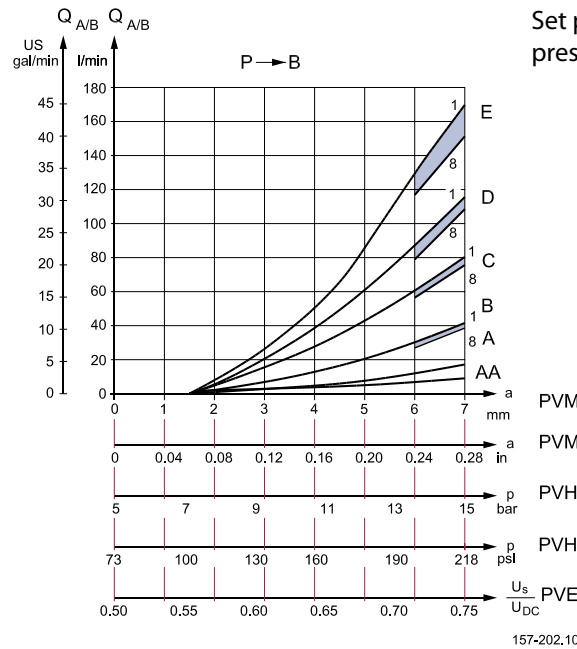
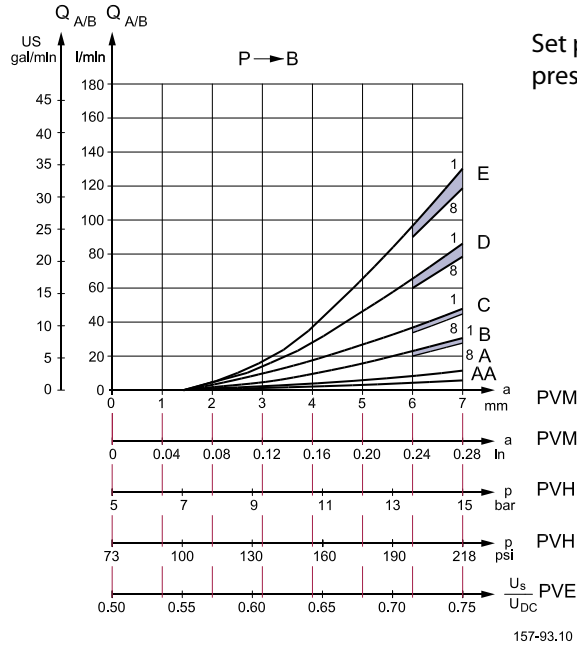

The oil flow is dependent on the pressure difference between the pump pressure and the LS signal. Normally the pressure difference is set at the LS pump regulator. Also take into consideration pressure drop from the pump to the PVG valve group. e.x. long pipeline.

**PVB, Basic Module
(continued)**

Characteristic for pressure drop PVB at max. main spool travel

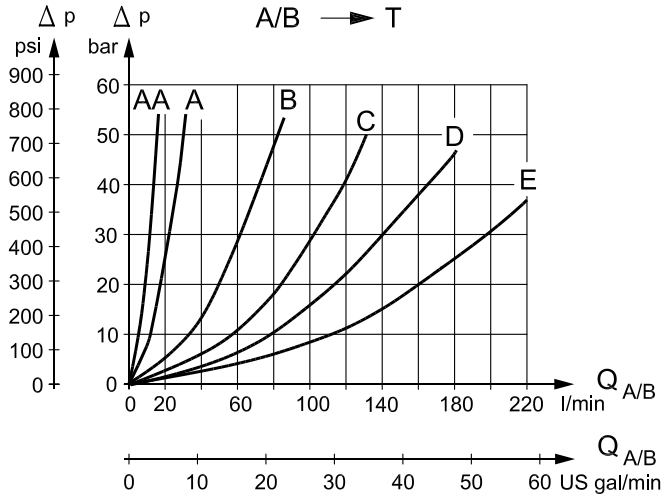

157-97.10

Characteristic for pressure drop PVB for open spool in neutral position

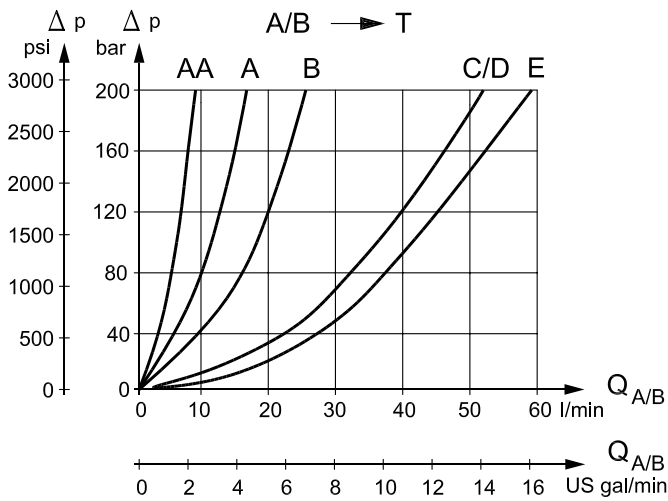

157-203.10

**PVB, Basic Module
(continued)**

Load-independent oil flow characteristic, pressure-compensated PVB

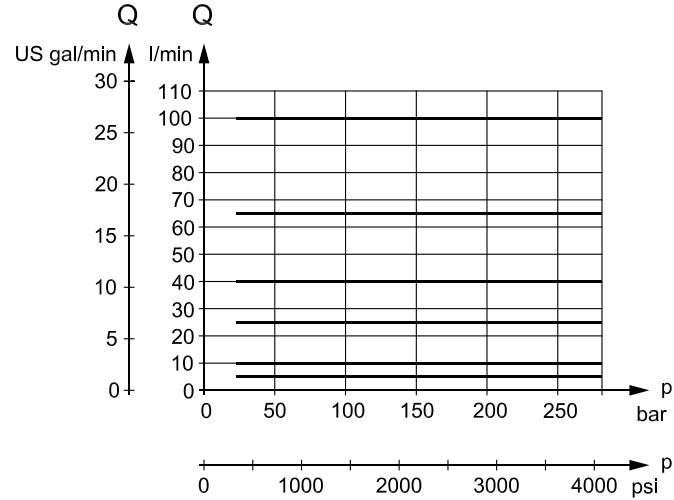

157-89.10

Oil flow characteristic at LS pressure limiting, pressure-compensated PVB

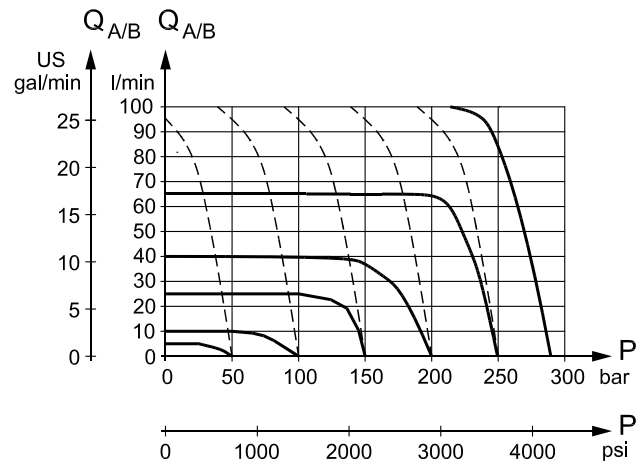

157-87.10

PVLP, Shock and Suction Valve

PVLP, shock valve

PVLP is set at an oil flow of 10 l/min [2.6 US gal/min]. The shock valve PVLP is designed to absorb shock effects. Consequently, it should not be used as a pressure relief valve.

If the working function requires the use of a pressure relief valve, a PVB basic module with built-in LSA/B pressure limiting valve should be used.

PVLP, shock valve characteristic

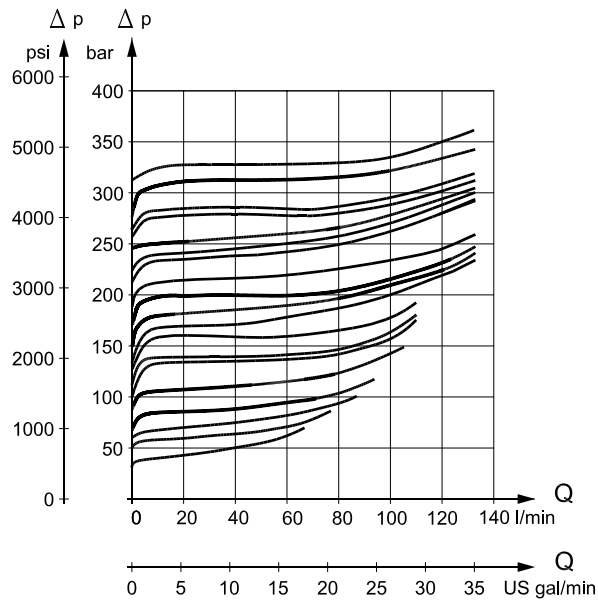

157-312.10

PVLA, Suction Valve

PVLA, suction valve characteristic

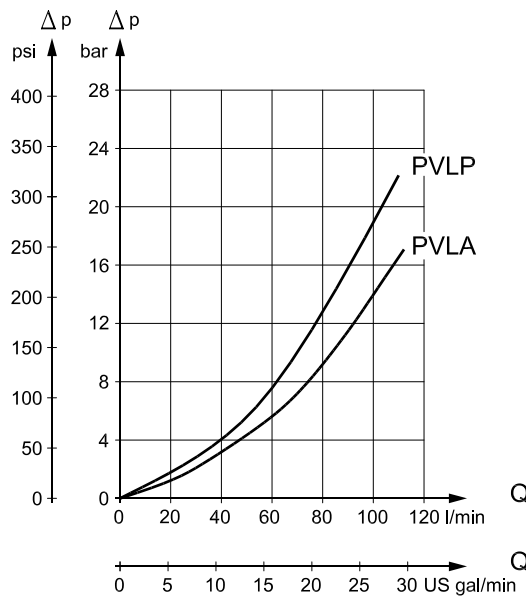

157-313.10

Pressure Control Spool Flow Characteristics in Various Positions

Size A:

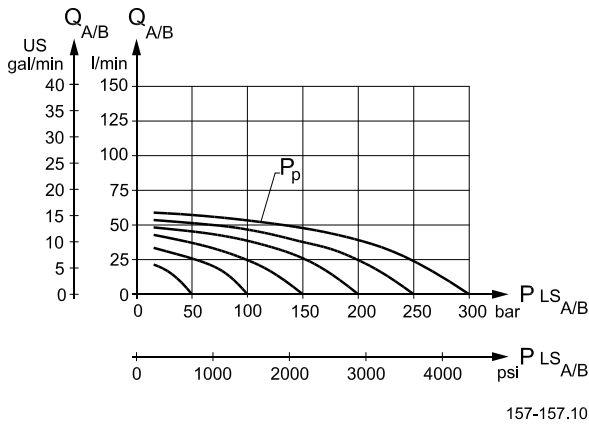

Size B:

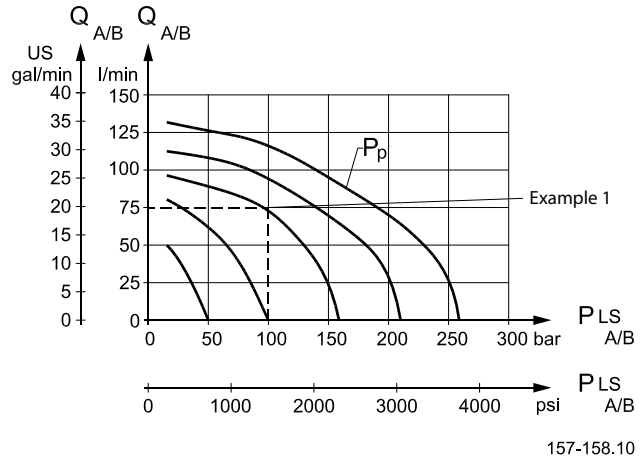

Size C:

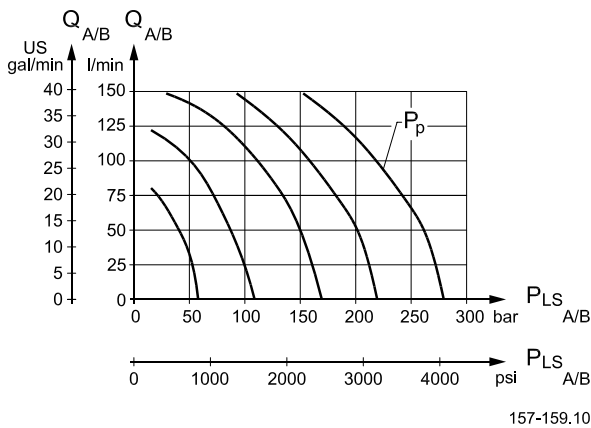

Size D:

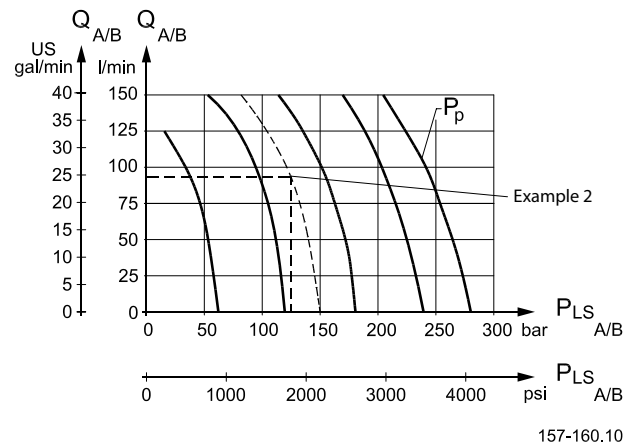

Size E:

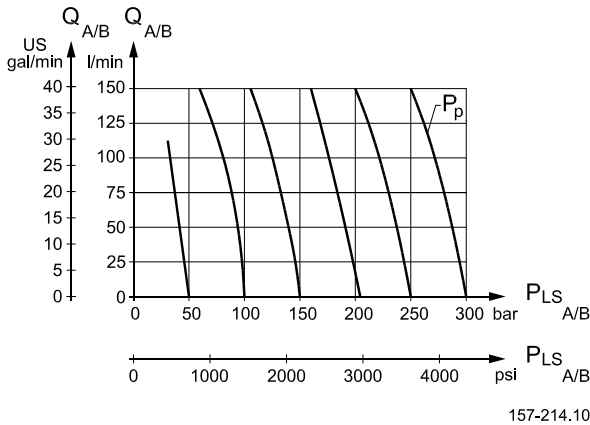

**Pressure Build-up for
 Pressure Controlled
 Spools**

Max. oil flow can be reduced by about 50% without limitation of maximum pressure by limiting the main spool travel from 7 mm [0.28 in] to 5.5 mm [0.22 in].

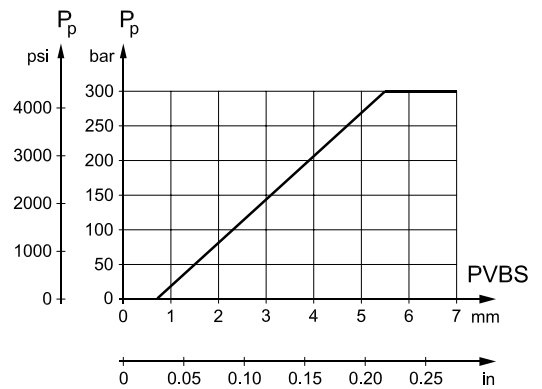

157-156.10

**Examples of How To Use
 the Characteristics for
 Pressure Control Spools**

Example 1: Determining the oil flow

- Given:
 - Spool type B
 - Pressure setting P_p : 160 bar [2320 psi]
 - Load pressure, $LS_{A/B}$: 100 bar [1450 psi]
- Result:
 - Oil flow = 75 l/min [19.8 US gal/min]

Example 2: Determining the spool size

- Given:
 - Max. oil flow, $Q_{A/B}$: 90 l/min [23.8 US gal/min]
 - Pressure setting P_p : 150 bar [2175 psi]
 - Load pressure, P_{LS_A} : 125 bar [1810 psi]
- Result:
 - D spool (see *previous page, size D*)

Normally a smaller spool can be chosen with pressure control. It is our experience that the spool can be one size smaller than with normal flow control.

**Characteristics for Float
 Position Main Spools**

Characteristic of oil flow, spool travel and voltage

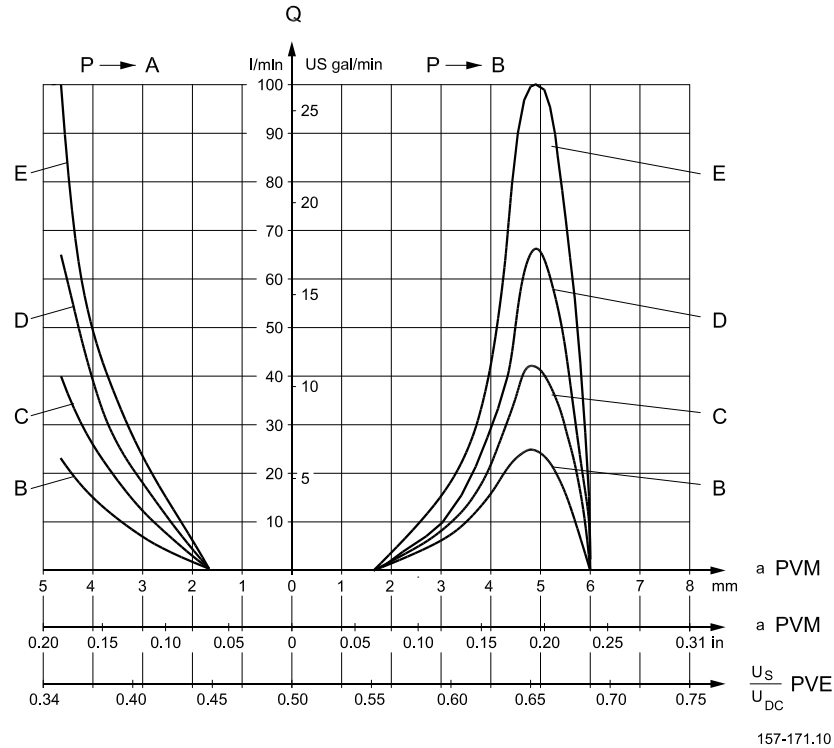

- 4.8 mm [0.19 in] spool displacement in direction A gives max. oil flow to port A
- 4.8 mm [0.19 in] spool displacement in direction B gives max. oil flow to port B
- 8 mm [0.32 in] spool displacement in direction B gives completely open float position A/B → T.

The spools have 4,8 mm spool travel in direction A and 8 mm travel in direction B:

For more information regarding electrical actuation of float spools please see *PVE series 4 Technical Information, 520L0553*.

**Characteristics for Float
Position Main Spools
(continued)**

Pressure drop A/B → T at max. spool travel within the proportional range (4.8 mm) [0.19 in]

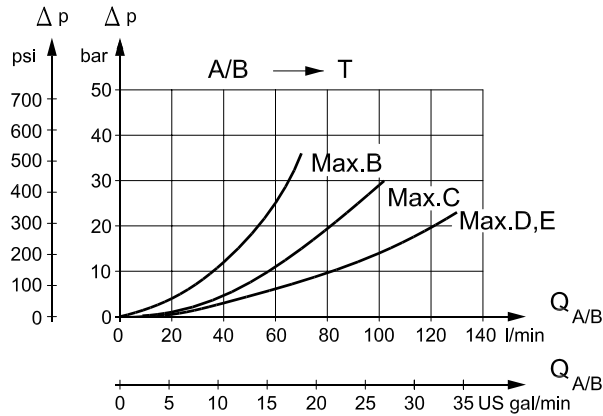

157-181.10

Spools D and E have the same opening area for forward flow and return flow. Spool E can give 100 l/min [26.4 US gal/min] pressure compensated oil flow due to a higher pressure drop across spool E. This occurs during spool actuation only.

Pressure drop A/B → T in float position

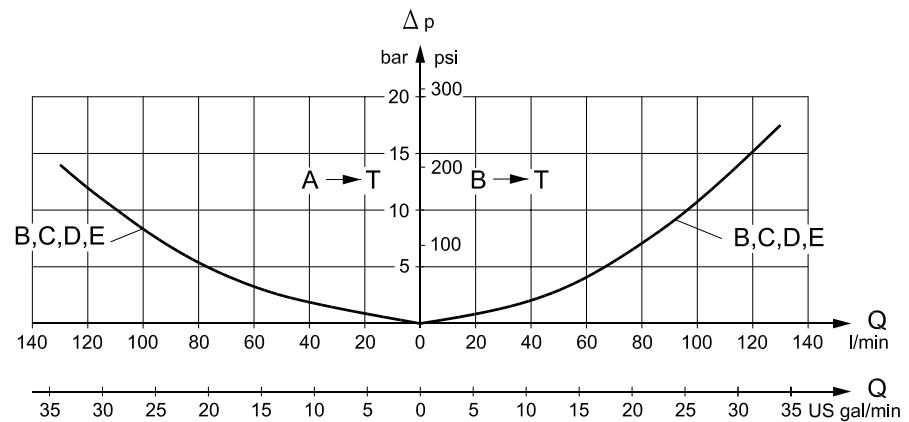

157-172.10

Dimensions

PVG 32 Dimensions

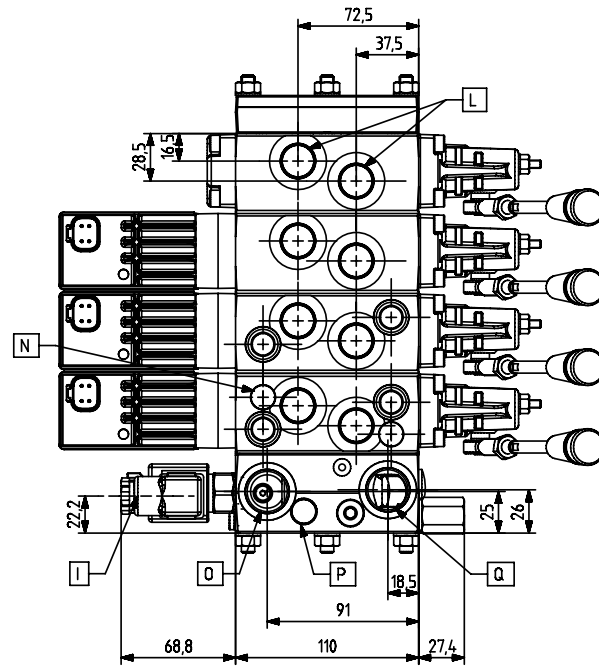
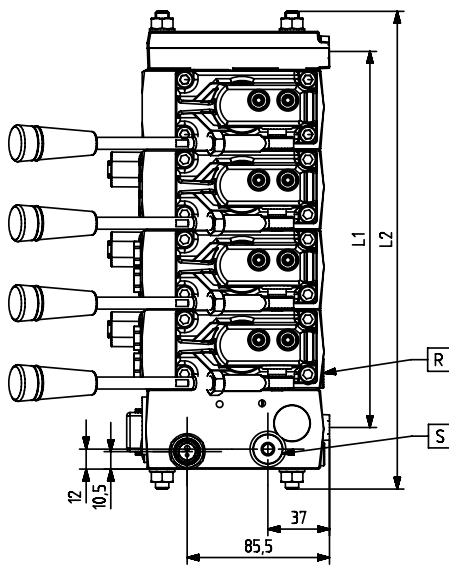
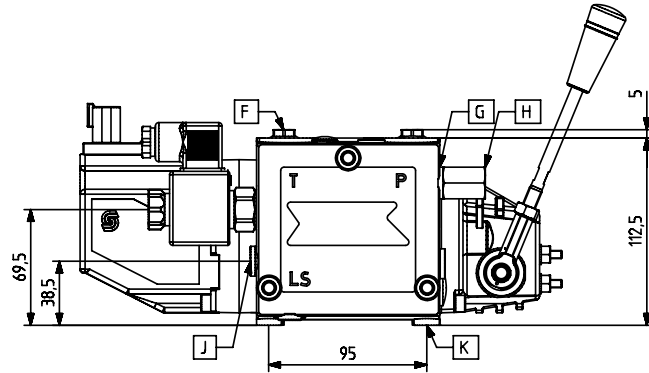

V310344.C

- F: Shock and suction valve, PVLP
- G: Pressure gauge connection; G $\frac{1}{4}$, 12 mm [$\frac{9}{16}$ -18, 0.5 in] deep
- H: Plug for external pilot oil supply, PVPC; G $\frac{1}{2}$, 12 mm [$\frac{1}{2}$ -20, 0.47 in] deep
- I: Electrical LS unloading valve, PVPX
- J: LS connection: G $\frac{1}{4}$, 12 mm [$\frac{1}{2}$ -20; 0.47 in or $\frac{9}{16}$ -18, 0.5 in] deep
- K: Fixing holes: M8 \times min. 10 [$\frac{5}{16}$ -18; 0.39 in] deep
- L: Port A and B: G $\frac{1}{2}$, 14 mm [$\frac{7}{8}$ -14; 0.65 in] deep

- M: LX connection: PVS; G $\frac{1}{8}$, 10 mm [$\frac{3}{8}$ -24; 0.39 in] deep and PVSI; G $\frac{1}{4}$, 12 mm [$\frac{1}{2}$ -20; 0.47 in] deep
- N: LS pressure limiting valve
- O: Tank connection; G $\frac{3}{4}$, 16 mm [$1\frac{1}{16}$ -12; 0.75 in] deep
- P: Pressure relief valve
- Q: Pump connection; G $\frac{1}{2}$, 14 mm [$\frac{7}{8}$ -14; 0.65 in] deep or G $\frac{3}{4}$, 16 mm [$1\frac{1}{16}$ -12; 0.75 in] deep
- R: LS_A and LS_B connections; G $\frac{1}{4}$, 12 mm deep [$\frac{9}{16}$ -18, 0.5 in] deep
- S: Pp, pilot pressure connection G $\frac{1}{4}$

PVB		1	2	3	4	5	6	7	8	9	10	11	12
L1	mm	82	130	178	226	274	322	370	418	466	514	562	610
	[in]	[3.23]	[5.12]	[7.01]	[8.90]	[10.79]	[12.68]	[14.57]	[16.46]	[18.35]	[20.24]	[562]	[610]
L2	mm	140	189	238	287	336	385	434	483	527	576	622	670
	[in]	[5.51]	[7.44]	[9.37]	[11.30]	[13.23]	[15.16]	[17.09]	[19.02]	[20.95]	[22.87]	[622]	[670]

Dimensions (continued)

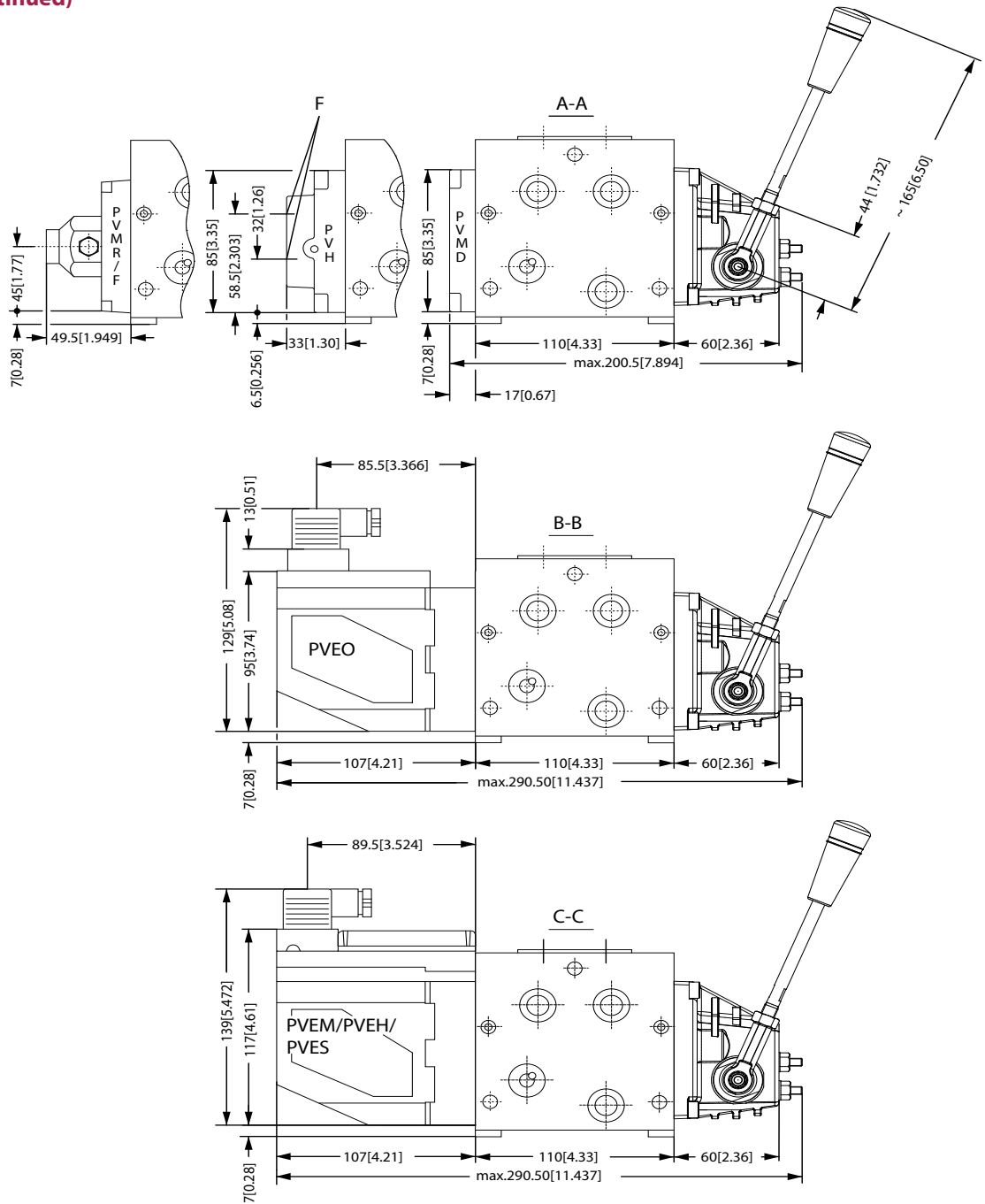

V310141.A

F: G ¹/₄, 12 mm deep [¹/₂ in - 20, 0.47 in deep]

Control Lever Positions

Mounted with an angle of 22.5°

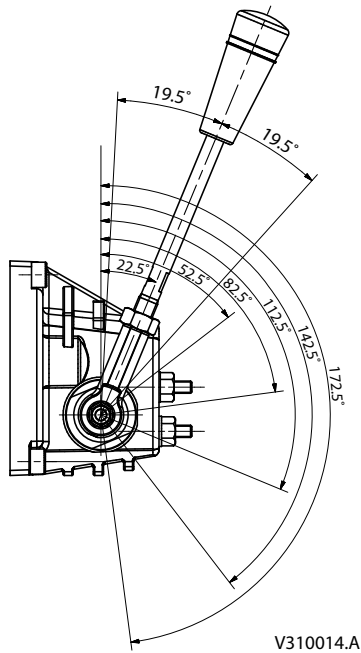

Mounted with an angle of 37.5°

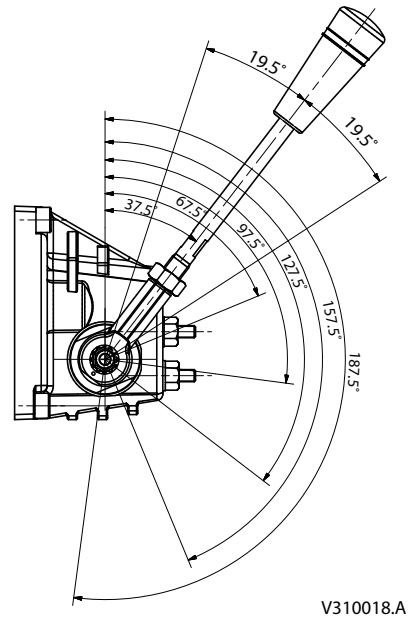

The angle of the handle is determined by which side of the handle that is mount towards the base. If a 22.5° angle is needed the "dot" on the handle is not visible. If 37.5° is needed the dot should be visible.

Surface Treatment

The PVG valve has as standard, an untreated surface. In certain applications, depend on different factors, such as: salty environment, large temperature changes, high humidity, rust can develop on the surface. This will not affect the performance of the PVG valve group.

To prevent/reduce rust development, Sauer-Danfoss recommend, the PVG valve group to be painted.

Rust on the surface is not seen as a valid complaint issue, neither on painted or unpainted PVG valve groups.

Manually Actuated PVG 32 – Fixed Displacement Pump

Example of manually actuated PVG 32 – fixed displacement pump schematic

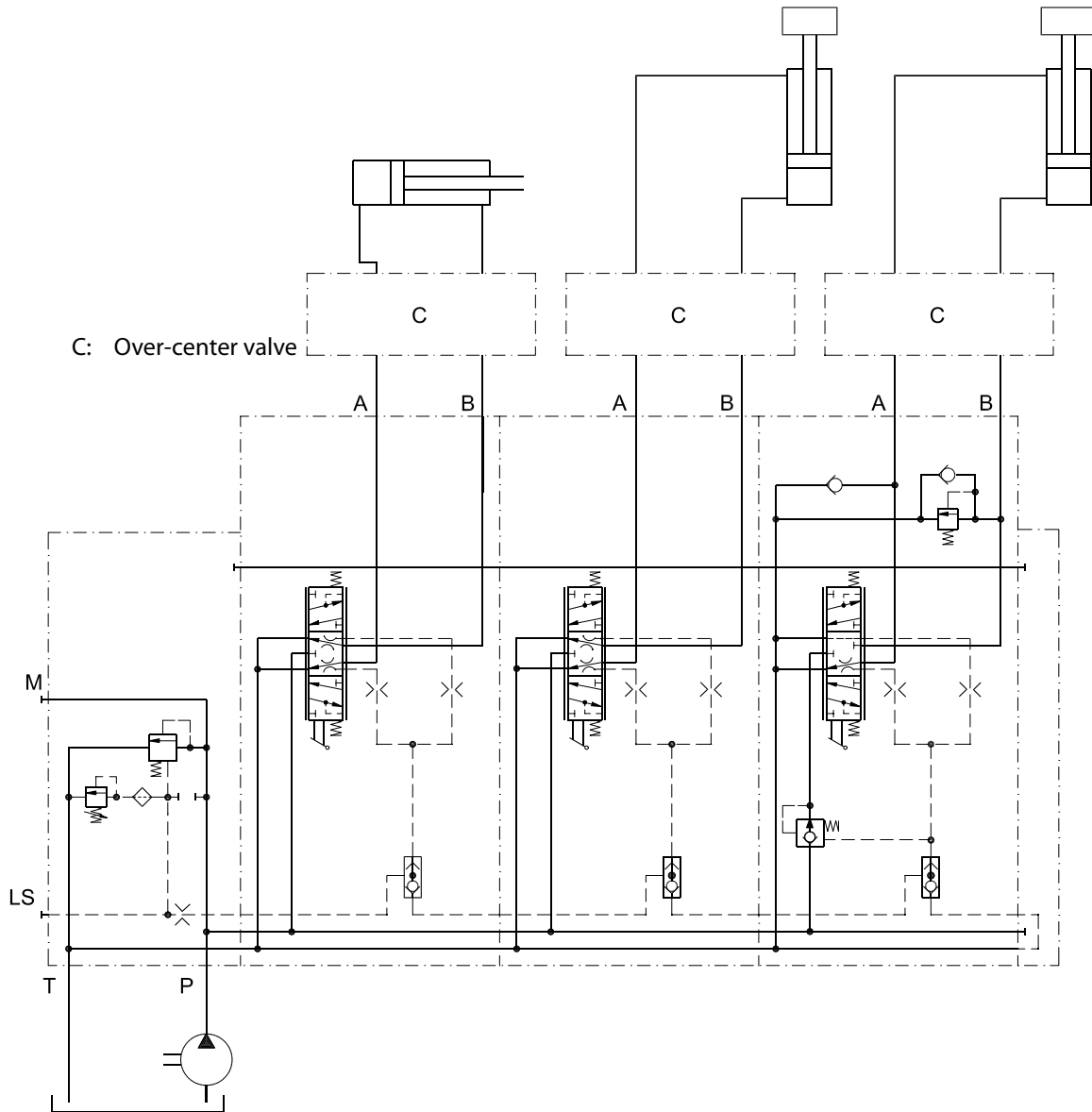

157-55.10

Electrically Actuated PVG 32 – Variable Displacement Pump

Example of electrically actuated PVG 32 – variable displacement pump (electrical actuator, shock valves, relief valve) schematic

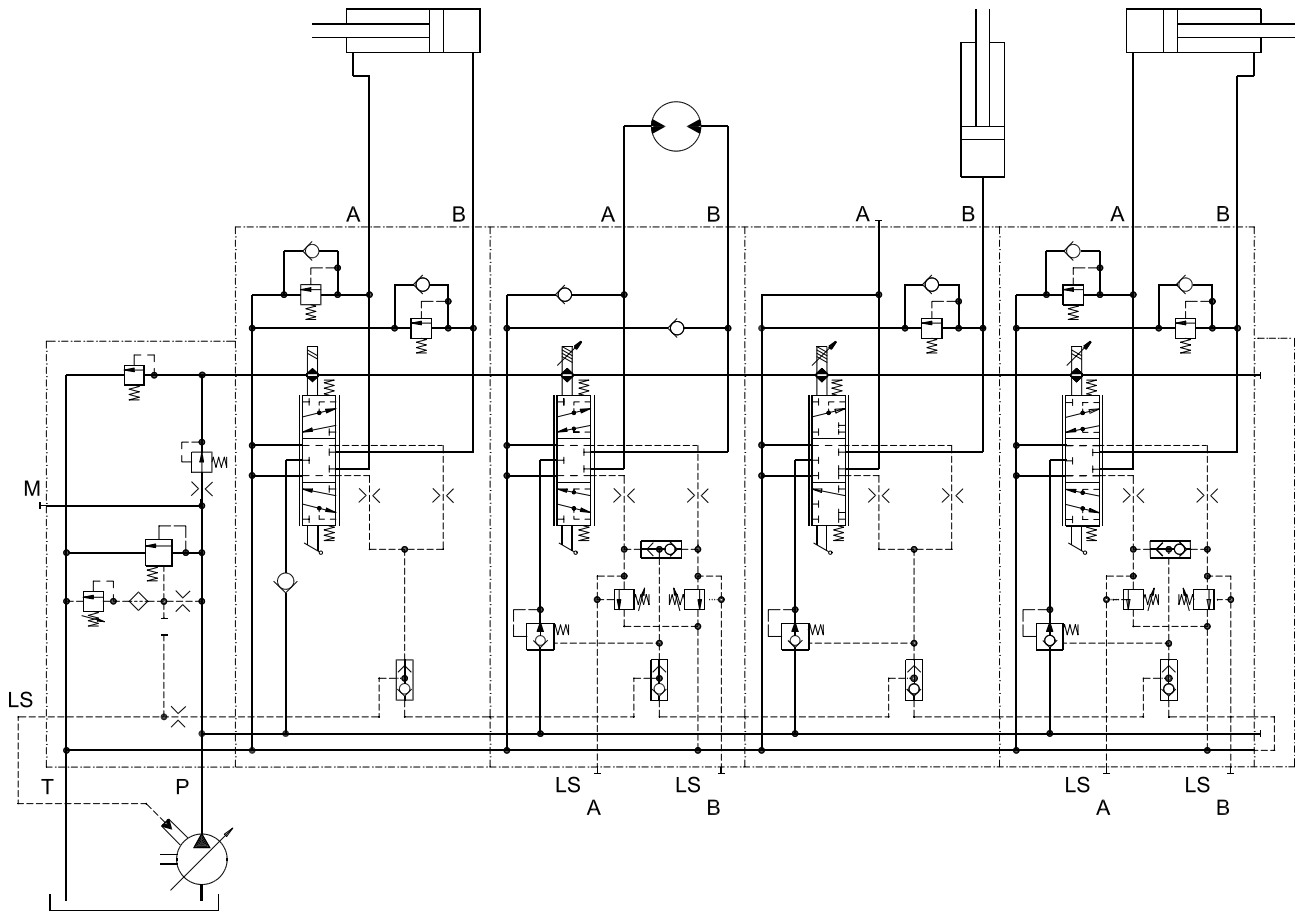

157-56.10

Oil

The main duty of the oil in a hydraulic system is to transfer energy. It must also lubricate the moving parts in hydraulic components, protect them against corrosion, and transport dirt particles and heat out of the system. It is therefore important to choose the correct oil with the correct additives. This gives normal operation and long working life.

Mineral oil

For systems with PVG 32 valves Sauer-Danfoss recommends the use of mineral-based hydraulic oil containing additives: Type HLP (DIN 51524) or HM (ISO 6743/4).

Non-flammable fluids

Phosphate-esters (HFDR fluids) can be used without special precautions. However, dynamic seals must be replaced with FPM (Viton) seals.

Please contact the Sauer-Danfoss Sales Organization if the PVG 32 valve is to be used with phosphate-esters.

The following fluids should only be used according to agreement with the Sales Organization for Sauer-Danfoss:

- Water-glycol mixtures (HFC fluids)
- Water-oil emulsions (HFB fluids)
- Oil-water emulsions (HFAE fluids)

Particle Content, Degree of Contamination

Biodegradable oils

PVG 32 valves can be used in systems with rapeseed oil. The use of rapeseed oil is conditioned by:

- complying with the demands on viscosity, water content, temperature and filtering etc. (see chapters below and technical data).
- adapting the operating conditions to the directions of the oil supplier.

Before using other biodegradable fluids, please consult the Sauer-Danfoss Organization.

Oil filtration must prevent particle content from exceeding an acceptable level, i.e., an acceptable degree of contamination.

Maximum contamination for PVG 32 is 23/19/16 (see ISO 4406. Calibration in accordance with the ACFTD method).

In our experience a degree of contamination of 23/19/16 can be maintained by using a filter fineness as described in the next section.

For more information, please see the Sauer-Danfoss literature:

- *Design Guidelines for Hydraulic Fluid Cleanliness Technical Information*, **520L0467**
- *Hydraulic Fluids and Lubricants Technical Information*, **521L0463**
- *Experience with Bio-Hydraulic Fluids Technical Information*, **521L0465**.

Filtration

Effective filtration is the most important precondition in ensuring that a hydraulic system performs reliably and has a long working life. Filter manufacturers issue instructions and recommendations. It is advisable to follow these.

System filters

Where demands on safety and reliability are very high a pressure filter with bypass and indicator is recommended. Experience shows that a 10 µm nominal filter (or finer) or a 20 µm absolute filter (or finer) is suitable.

It is our experience that a return filter is adequate in a purely mechanically operated valve system.

The fineness of a pressure filter must be selected as described by the filter manufacturer so that a particle level of 23/19/16 is not exceeded.

The filter must be fitted with pressure gauge or dirt indicator to make it possible to check the condition of the filter.

In systems with differential cylinders or accumulators the return filter must be sized to suit the max. return oil flow. Pressure filters must be fitted to suit max. pump oil flow.

Internal filters

The filters built into PVG 32 are not intended to filter the system but to protect important components against large particles. Such particles can appear in the system as a result of pump damage, hose fracture, use of quick-couplings, filter damage, starting up, contamination, etc.

The filter in the electrical actuator PVE protecting the solenoid valves has a mesh of 150 µm.

Bursting pressure drop for internal filters is 25 bar [360 psi].



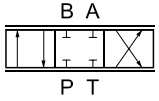
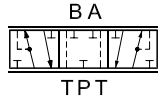
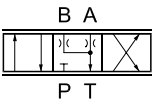
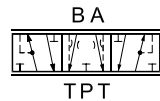
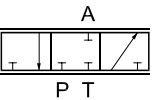
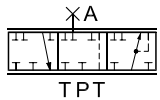
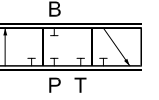
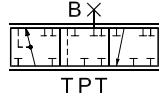

Standard FC Spools

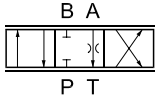
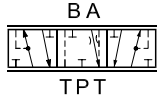
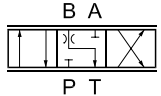
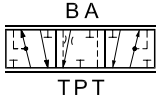
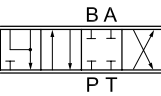
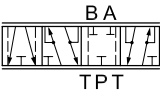
To be used when PVB is with LS _{A/B} shuttle valve							Code number 157B....	To be used when PVB is without LS _{A/B} shuttle valve							
Size								Size							
Press. compensated flow l/min [US gal/min]								ISO symbol	Symbol	Press. compensated flow l/min [US gal/min]					
F 130 [34.3]	E 100 [26.4]	D 65 [17.2]	C 40 [10.6]	B 25 [6.6]	A 10 [2.6]	AA 5 [1.3]	AA 5 [1.3]			A 10 [2.6]	B 25 [6.6]	C 40 [10.6]	D 65 [17.2]	E 100 [26.4]	F 130 [34.3]
7026	7024	7023	7022	7021	7020	7025	  157-02.10 157-26.10 4-way, 3-position Closed neutral position	7005	7000	7001	7002	7003	7004	7006	
7126	7124	7123	7122	7121	7120	7125	  157-03.10 157-27.10 4-way, 3-position Throttled, open neutral position	7105	7100	7101	7102	7103	7104	7106	
-	-	-	-	-	-	-	  157-04.10 157-28.10 3-way, 3-position Closed neutral position, P → A	-	7200	7201	7202	7203	7204	-	
-	-	-	-	-	-	-	  157-05.10 157-29.10 3-way, 3-position Closed neutral position, P → B	-	-	7301	7302	7303	7304	-	

Standard FC Spools

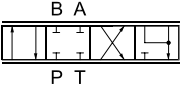
To be used when PVB is with LS _{A/B} shuttle valve							Code number 157B....		To be used when PVB is without LS _{A/B} shuttle valve						
Size							ISO symbol	Symbol	Size						
Press. compensated flow l/min [US gal/min]									Press. compensated flow l/min [US gal/min]						
F	E	D	C	B	A	AA	ISO symbol	Symbol	AA	A	B	C	D	E	F
130 [34.3]	100 [26.4]	65 [17.2]	40 [10.6]	25 [6.6]	10 [2.6]	5 [1.3]			5 [1.3]	10 [2.6]	25 [6.6]	40 [10.6]	65 [17.2]	100 [26.4]	130 [34.3]
-	7424	7423	7422	7421	-	-	 157-06.10 4-way, 3-position Throttled, A → T in neutral position	 157-30.10	-	-	7401	7402	7403	7404	7406
-	7524	7523	7522	7521	-	-	 157-07.10 4-way, 3-position Throttled, B → T in neutral position	 157-31.10	-	-	7501	7502	7503	7504	-
-	7624	7623	7622	7621	7620	-	 157-139.10 4-way, 4-position Closed neutral position Float P → B → F	 157-140.10	-	-	-	-	-	-	-

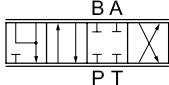
FC Spools for Mechanical Float Position PVMF

To be used when PVB is with LS _{A/B} shuttle valve							Code number 157B....	To be used when PVB is without LS _{A/B} shuttle valve							
Size								Size							
Press. compensated flow l/min [US gal/min]								ISO symbol	Symbol	Press. compensated flow l/min [US gal/min]					
F 130 [34.3]	E 100 [26.4]	D 65 [17.2]	C 40 [10.6]	B 25 [6.6]	A 10 [2.6]	AA 5 [1.3]	AA 5 [1.3]			A 10 [2.6]	B 25 [6.6]	C 40 [10.6]	D 65 [17.2]	E 100 [26.4]	F 130 [34.3]
-	9824	9823	9822	9821	9820	9825	 <p>157-09.10</p>  <p>157-454.10</p> <p>4-way, 4 position Closed neutral position P → A → F</p>	-	-	-	-	-	-	-	
-	9624	623	9622	9621	-	-	 <p>157-139.10</p>  <p>157-140.10</p> <p>4-way, 4-position Closed neutral position Float P → B → F</p>	-	-	-	-	-	-	-	

Standard FC Spools, Hydraulic Actuation

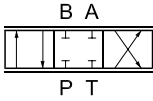
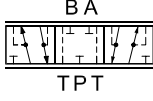
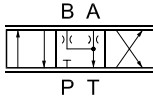
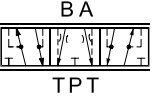
To be used when PVB is with LS _{A/B} shuttle valve						Code number 157B....		To be used when PVB is without LS _{A/B} shuttle valve					
Size						ISO symbol	Symbol	Size					
Press. compensated flow l/min [US gal/min]								Press. compensated flow l/min [US gal/min]					
E 100 [26.4]	D 65 [17.2]	C 40 [10.6]	B 25 [6.6]	A 10 [2.6]	AA 5 [1.3]			AA 5 [1.3]	A 10 [2.6]	B 25 [6.6]	C 40 [10.6]	D 65 [17.2]	E 100 [26.4]
9024	9023	9022	9021	9020	9025	 157-02.10 4-way, 3-position closed neutral position	 157-117.10	9005	9000	9001	9002	9003	9004
9124	9123	9122	9121	9120	9125	 157-03.10 4-way, 3-position Throttled open neutral position	 157-118.10	9105	9100	9101	9102	9103	9104



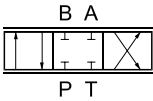
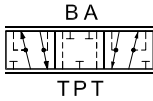
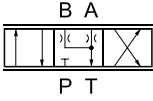
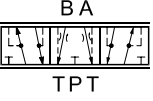

PVMR, FC Spools for Friction Detent

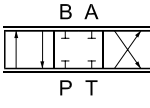
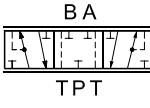
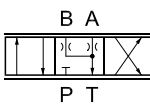
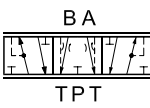
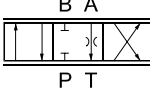
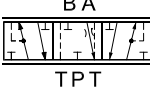
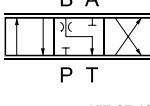
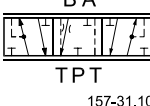
To be used when PVB is with LS _{A/B} shuttle valve						Code number 157B....		To be used when PVB is without LS _{A/B} shuttle valve					
Size						ISO symbol	Symbol	Size					
Press. compensated flow l/min [US gal/min]								Press. compensated flow l/min [US gal/min]					
E 100 [26.4]	D 65 [17.2]	C 40 [10.6]	B 25 [6.6]	A 10 [2.6]	AA 5 [1.3]			AA 5 [1.3]	A 10 [2.6]	B 25 [6.6]	C 40 [10.6]	D 65 [17.2]	E 100 [26.4]
9724	9723	9722	9721	9720	-	 157-02.10 4-way, 3-position closed neutral position	 157-117.10	-	9700	9701	9702	9703	9704
9734	9733	9732	9731	9730	-	 157-03.10 4-way, 3-position Throttled open neutral position	 157-118.10	-	9710	9711	9712	9713	9714

FC Spools with Linear Flow Characteristic

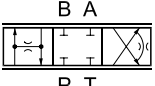
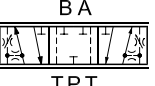
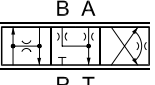
To be used when PVB is with LS _{A/B} shuttle valve							Code number 157B....		To be used when PVB is without LS _{A/B} shuttle valve						
Size							ISO symbol	Symbol	Size						
Press. compensated flow l/min [US gal/min]									Press. compensated flow l/min [US gal/min]						
F 130 [34.3]	E 100 [26.4]	D 65 [17.2]	C 40 [10.6]	B 25 [6.6]	A 10 [2.6]	AA 5 [1.3]			AA 5 [1.3]	A 10 [2.6]	B 25 [6.6]	C 40 [10.6]	D 65 [17.2]	E 100 [26.4]	F 130 [34.3]
-	9774	9773	9772	9771	-	-	 B A P T 157-02.10	 B A TPT 157-26.10	-	9750	9751	9752	9753	9754	-
-	9784	9783	9782	9781	-	-	 B A P T 157-03.10	 B A TPT 157-27.10	-	9760	9761	9762	9763	9764	-
-	-	-	-	-	-	-	 B A P T 157-06.10	 B A TPT 157-30.10	-	-	-	-	-	9794	-
-	-	-	-	-	-	-	 B A P T 157-07.10	 B A TPT 157-31.10	-	-	-	-	-	9804	-

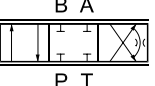
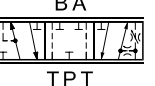
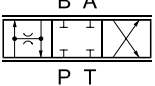
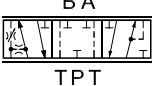
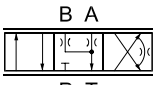
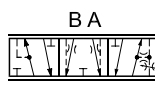
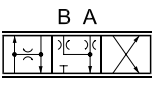

Standard PC Spools

To be used when PVB is with LS _{A/B} shuttle valve						Code number 157B....		To be used when PVB is without LS _{A/B} shuttle valve					
Size						ISO symbol	Symbol	Size					
Press. compensated flow l/min [US gal/min]								Press. compensated flow l/min [US gal/min]					
E 100 [26.4]	D 65 [17.2]	C 40 [10.6]	B 25 [6.6]	A 10 [2.6]	AA 5 [1.3]			AA 5 [1.3]	A 10 [2.6]	B 25 [6.6]	C 40 [10.6]	D 65 [17.2]	E 100 [26.4]
-	7033	7032	7031	7030	7035	 P T 157-143.10	 TPT 157-121.10	7015	7010	7011	7012	7013	-
7134	7133	7132	7131	7130	7135	 P T 157-146.10	 TPT 157-128.10	7115	7110	7111	7112	7113	-
7064	7063	7062	7061	-	-	 P T 157-144.10	 TPT 157-123.10	-	7040	7041	7042	7043	7044
7074	7073	7072	7071	-	-	 P T 157-145.10	 TPT 157-122.10	-	7050	7051	7052	7053	7054
7164	7163	7162	7161	-	-	 P T 157-147.10	 TPT 157-130.10	-	7150	7151	7152	7153	7154
7174	7173	7172	7171	-	-	 P T 157-148.10	 TPT 157-132.10	-	7150	7151	7152	7153	7154

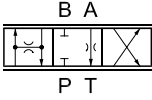
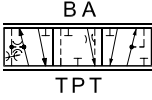
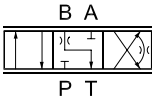
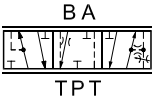
Standard PC Spools

To be used when PVB is with LS _{A/B} shuttle valve						Code number 157B....		To be used when PVB is without LS _{A/B} shuttle valve					
Size						ISO symbol	Symbol	Size					
Press. compensated flow l/min [US gal/min]								Press. compensated flow l/min [US gal/min]					
E 100 [26.4]	D 65 [17.2]	C 40 [10.6]	B 25 [6.6]	A 10 [2.6]	AA 5 [1.3]			AA 5 [1.3]	A 10 [2.6]	B 25 [6.6]	C 40 [10.6]	D 65 [17.2]	E 100 [26.4]
-	7473	7472	7471	7470	-	 157-149.10 4-way, 3-position Throttled, A → T neutral position, PC → B	 157-142.10	-	-	-	7452	7453	-
-	7563	7562	-	-	-	 157-167.10 4-way, 3-position Throttled, B → T neutral position, PC → A	 157-188.10	-	-	7541	7542	7543	-

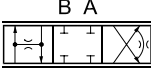
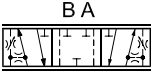
Standard PC Spools, Hydraulic Actuation

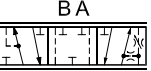
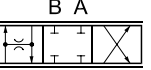
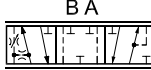
To be used when PVB is with LS _{A/B} shuttle valve						Code number 157B....		To be used when PVB is without LS _{A/B} shuttle valve					
Size						ISO symbol	Symbol	Size					
Press. compensated flow l/min [US gal/min]								Press. compensated flow l/min [US gal/min]					
E	D	C	B	A	AA	ISO symbol	Symbol	AA	A	B	C	D	E
100 [26.4]	65 [17.2]	40 [10.6]	25 [6.6]	10 [2.6]	5 [1.3]			5 [1.3]	10 [2.6]	25 [6.6]	40 [10.6]	65 [17.2]	100 [26.4]
-	-	-	-	-	-	 P T 157-143.10	 TPT 157-121.10	9015	9010	9011	9012	-	-
-	-	-	-	-	-	 P T 157-144.10	 TPT 157-123.10	-	-	-	9042	9043	9044
-	-	-	-	-	-	 P T 157-145.10	 TPT 157-122.10	-	-	-	9052	9053	9054

PVB, basic valves

Description	No facilities for shock valves A and B		Facilities for shock valves A and B	
	G ½	7/8 - 14 UNF	G ½	7/8 - 14 UNF
Without compensator /check valve	157B6000	157B6400	157B6030	157B6430
With check valve	157B6100	157B6500	157B6130	157B6530
With check valve and LS _{A/B} shuttle valve	-	-	157B6136	157B6536
With compensator valve	157B6200	157B6600	157B6230	157B6630
With damped compensator valve	157B6206	-	157B6236	-
With compensator valve, LS _{A/B} relief valve and LS _{A/B} shuttle valve	157B6203	157B6603	157B6233	157B6633
With damped compensator valve, LS _{A/B} relief valve and LS _{A/B} shuttle valve	157B6208	-	157B6238	-
Weight kg [lb]	3.1 [6.8]		3.0 [6.6]	

PVPC, plugs

Description	G ½	½ in - 20	Weight	
			kg	[lb]
External pilot supply	157B5400	—	0.05	0.1
External pilot supply incl. check valve	157B5600	157B5700	0.05	0.1

PVM, mechanical actuation

Description	Alu		Alu anodized	Cast iron	Angle
	with stop screws	without stop screws	with stop screws	with stop screws	
Standard	157B3171	157B3191	157B3184	157B3161	22,5°/37,5°
Standard with base, without arm and button	157B3174	157B3194	—	—	22,5°/37,5°
Standard without base, without arm and button	157B3173	157B3193	157B3186	—	—
Weight kg [lb]	0.4 [0.9]			0.8 [1.8]	

PVAS, assembly kit

Code no.	0	1	2	3	4	5	6	7	8	9	10	11	12
PVB's	157B8000	157B8001	157B8002	157B8003	157B8004	157B8005	157B8006	157B8007	157B8008	157B8009	157B8010	157B8061	157B8062
PVB + PVPVM	-	157B8021	157B8022	157B8023	157B8024	157B8025	157B8026	157B8027	157B8028	157B8029	157B8030	157B8081	157B8082
Weight kg [lb]	0.1 [0.2]	0.15 [0.3]	0.25 [0.6]	0.30 [0.7]	0.40 [0.9]	0.45 [1.0]	0.50 [1.1]	0.60 [1.3]	0.65 [1.4]	0.70 [1.6]	0.80 [1.7]	0.85 [1.8]	0.9 [2.0]

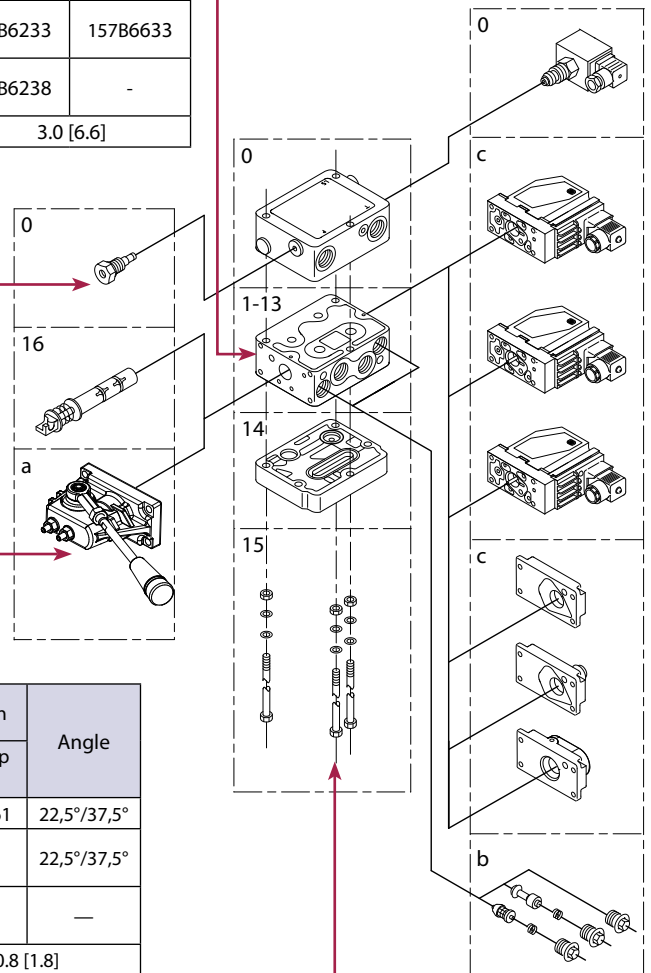

V310168.A

PVP, pump side module

Description		Without pilot supply		With pilot supply			
		for PVE	for PVE with facilit. for PVPX	for PVE	for PVE and facilit. for PVPX	for PVE and pilot oil pressure take-off	for PVH and pilot oil pressure take-off
Open center	P = G ^{1/2} , T = G ^{3/4}	157B5000	-	157B5010	157B5012	-	-
	P = 7/8-14, T = 1 ^{1/16} -12	157B5200	-	157B5210	157B5212	-	-
	P = G ^{3/4} , T = G ^{3/4}	157B5100	157B5102	157B5110	157B5112	157B5180	157B5190
	P = 1 ^{1/16} -12, T = 1 ^{1/16} -12	157B5300	-	157B5310	157B5312	157B5380	157B5390
Closed center	P = G ^{1/2} , T = G ^{3/4} ,	157B5001	-	157B5011	157B5013	-	-
	P = 7/8-14, T = 1 ^{1/16} -12	157B5201	-	157B5211	157B5213	-	-
	P = G ^{3/4} , T = G ^{3/4} ,	157B5101	157B5103	157B5111	157B5113	157B5181	157B5191
	P = 1 ^{1/16} -12, T = 1 ^{1/16} -12	157B5301	-	157B5311	157B5313	157B5381	157B5391
Weight	kg [lb]	3 [6.6]					

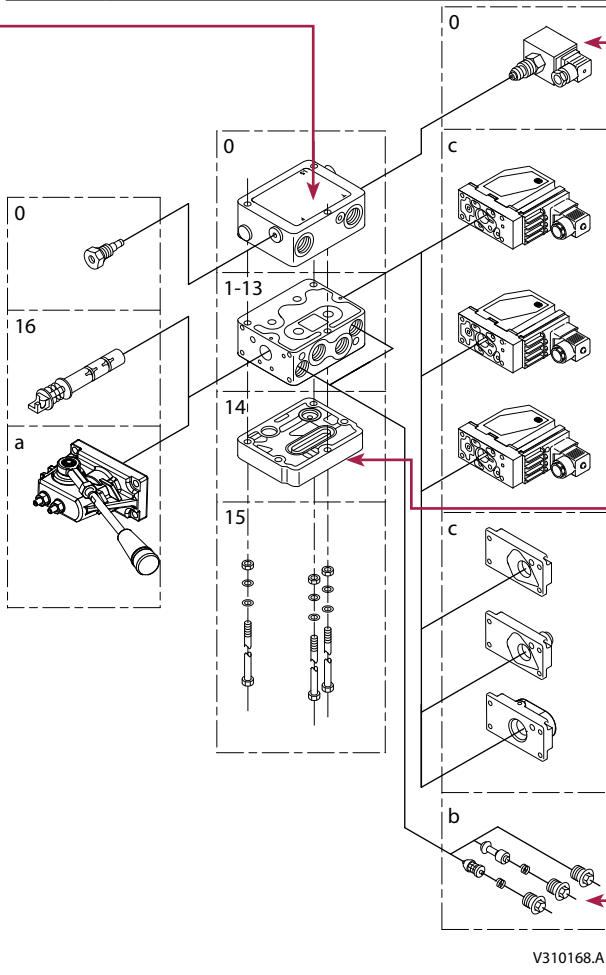

PVPX, electrical LS pressure relief valves

Description/ Supply voltage	Code No. Hirsch.	Code No. AMP	Weight kg [lb]
Normally open	12 V	157B4236	157B4981
	24 V	157B4238	157B4982
Normally closed	12 V	157B4246	157B4983
	24 V	157B4248	157B4984
Normally open with manual override	12 V	157B4256	157B4985
	24 V	157B4258	157B4986
Plug	157B5601		0.06 [0.13]

PVS and PVS1, End plate

Description	BSP	SAE	Weight kg [lb]
PVS, without connections	157B2000	157B2020	0.5 [1.1]
PVS, with LX connection G 1/8 [3/8 -24 UNF]	157B2011	157B2021	
PVS1, without connections	157B2014	157B2004	1.7 [3.6]
PVS1, with LX connections G 1/4 [1/2 -20 UNF]	157B2015	157B2005	

PVLP, shock/ and anti-cavitation valves

Code no.	157B2032	157B2050	157B2063	157B2080	157B2100	157B2125	157B2140	157B2150	157B2160	157B2175	157B2190	
Settings	bar	32	50	63	80	100	125	140	150	160	175	190
	[psi]	460	725	914	1160	1450	1813	2031	2175	2320	2538	2755
Weight for all	0.05 kg [0.17 lb]											
Code no.	157B2210	157B2230	157B2240	157B2250	157B2265	157B2280	157B2300	157B2320	157B2350	157B2380	157B2400	
Settings	bar	210	230	240	250	265	280	300	320	350	400	
	[psi]	3045	3335	3480	3625	3845	4061	4351	4641	5075	5801	

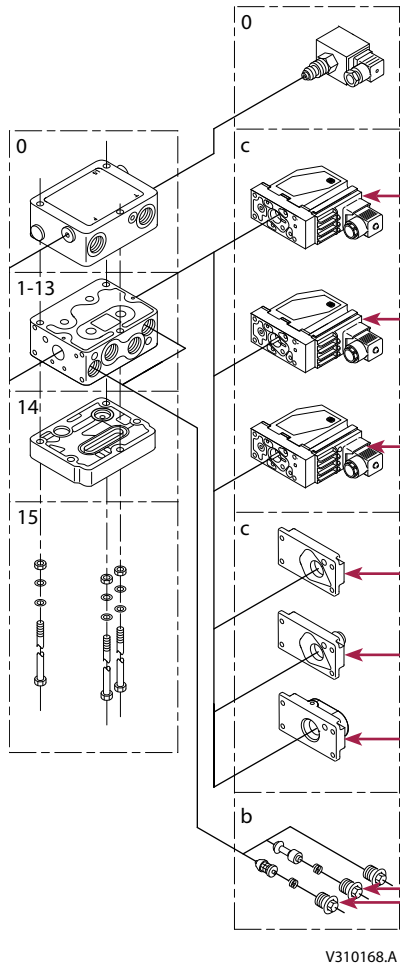

PVE, electrical actuation

Description	Code No.			Weight kg [lb]	
	Hirsch	AMP	Deut.		
PVEO, on-off	12 V	157B4216	157B4901	0.6 [1.3]	
	24 V	157B4228	157B4902		
PVEO-R, on/off	12 V	157B4217	157B4903	-	
	24 V	157B4229	157B4904	-	
PVEM, prop. medium - Standard	12 V	157B4116	-	-	0.9 [2.0]
	24 V	157B4128	-	-	
PVEM, prop. medium - Float -> B	12 V	157B4416	-	-	1.0 [2.2]
	24 V	157B4428	-	-	
PVEA, active fault mon.	-	-	157B4734	157B4792	0.9 [2.0]
PVEA, passive fault mon.	-	-	157B4735	-	
PVEA-DI, active fault mon.	-	-	157B4736	157B4796	-
PVEA-DI, passive fault mon.	-	-	157B4737	-	
PVEH active fault mon.	-	157B4032	157B4034	157B4092	1.0 [2.2]
PVEH passive fault mon.	-	157B4033	157B4035	157B4093	
PVEH float -> B, act. fault	-	157B4332	-	157B4392	
PVEH float -> A, act. fault	-	-	157B4338	-	
PVEH-DI active fault mon.	-	-	157B4036	157B4096	
PVEH-DI passive fault mon.	-	-	157B4037	-	
PVES, active fault mon.	-	157B4832	157B4834	157B4892	-
PVES, passive fault mon.	-	157B4833	157B4835	-	-

PVMD, PVMR, PVMF, PVH covers

Description	Code No.	Material	Anodized	Weight
				kg [lb]
PVMD Cover for PVB	157B0001	aluminium	no	0.1 [0.2]
	157B0009		yes	
	157B0021	cast iron	N/A	0.9 [2.0]
PVMR (Frict. Detent)	157B0004	aluminium	no	0.3 [0.6]
	157B0012		yes	
	157B0024	cast iron	N/A	
PVMF (Mech. float position)	157B0005	aluminium	no	0.2 [0.4]
Hydraulic actuation PVH 9/16-18 UNF	157B0007	aluminium	no	
	157B0010		yes	
	157B0014	cast iron	N/A	
Hydraulic actuation PVH G1/4	157B0008	aluminium	no	
	157B0011		yes	
	157B0016	cast iron	N/A	0.9 [2.0]

PVLA, anti-cavitation valve

Description	Code No.	Weight	
		kg	[lb]
Plug A or B	157B2002	0.04	0.09
Valve A or B	157B2001	0.05	0.1

Order Specification

An order form for Sauer-Danfoss PVG 32 hydraulic valve is shown on the next page. The form can be obtained from the Sauer-Danfoss Sales Organization.

Both the module selection chart on the previous pages and the order form are divided into fields 0, 1-1-12, 13, 14, 15, a, b, and c.

Each module has its own field:

0:

- Pump side module PVP
- Plug for external pilot oil supply PVPC
- Electrical LS unloading valve PVPX

1-12: Basic valves PVB

13: Main spool PVBS

a: Mechanical actuator PVM (or PVE when option mounted)

c:

- Cover for mechanical actuation PVMD
- Cover for hydraulic actuation PVH
- Electrical actuators PVE (or PVM when option mounted)

b:

- Shock and suction valve PVLP
- Suction valve PVLA

14: End plate PVS

15: Assembly kit PVAS

Please state

- Code numbers of all modules required
- Required setting (P) for pump side module
- Required setting of LS_{A/B} pressure limiting valves, see pressure setting guidance below.

Standard and option assembly

The PVG 32 valve group is assembled the way the module selection chart shows if the code number for PVM is written in field 'a', and the code number for PVMD, PVE or PVH in field 'c'.

The valve group is assembled so that the mechanical actuator is mounted on the opposite end of the basic module, if the code number for PVM is written in field 'c' of the order form and the code numbers for PVMD, PVE or PVH in field 'a'.

Reordering

The space at the top right-hand corner of the form is for Sauer-Danfoss to fill in. The code number for the whole of the specified valve group (PVG No.) is entered here. In the event of a repeat order all you have to do is enter the number Sauer-Danfoss has given on the initial confirmation of order.

**Order Specification
 (continued)**

Pressure setting limits

The maximum setting pressure for the pressure limiting valves LS_A or LS_B depends on the chosen pressure setting for shock valve PVLP. The maximum values recommended to avoid interaction can be read in the following table.

The figures in the table have been calculated according to the following expressions:

- PVLP ≤ 150 bar: $LS_{A/B} \leq 0.8 \times P_{PVLP}$
- PVLP > 150 bar: $P_{PVLP} - LS_{A/B} \geq 30$ bar.

Max. pressure setting of LS_A and LS_B valves relative to PVLP shock valve

Setting pressure for PVLP	bar	32	50	63	80	100	125	140	150	160	175	190	210	230	240	250	265	280	300	320	350	380	400
	[psi]	460	725	914	1160	1450	1813	2031	2175	2320	2838	2755	3045	3335	3480	3625	3843	4061	4351	4641	5075	5511	5801
Max. setting pressure for $LS_{A/B}$	bar	-	40	50	64	80	100	112	120	130	145	160	180	200	210	220	235	250	270	290	320	350	370
	[psi]	-	580	720	930	1160	1450	1625	1740	1885	2100	2320	2610	2900	3045	3190	3408	3625	3915	4205	4641	5075	5366
Min. setting pressure for $LS_{A/B}$	bar	30																					
	[psi]	435																					

Order Specification
 Forms

							
		Subsidiary/Dealer				PVG No.	
Customer						Customer Part No.	
Application						Revision No.	
Section		A-Port				B-Port	
v	Function	v				v	
0		157B	157B	157B	157B		
		p =	bar	157B			
1	a	157B	157B	157B	16	157B	
	b	157B	LS _A	bar	LS _B	bar	
						c	
						b	
2	a	157B	157B	157B	16	157B	
	b	157B	LS _A	bar	LS _B	bar	
						c	
						b	
3	a	157B	157B	157B	16	157B	
	b	157B	LS _A	bar	LS _B	bar	
						c	
						b	
4	a	157B	157B	157B	16	157B	
	b	157B	LS _A	bar	LS _B	bar	
						c	
						b	
5	a	157B	157B	157B	16	157B	
	b	157B	LS _A	bar	LS _B	bar	
						c	
						b	
6	a	157B	157B	157B	16	157B	
	b	157B	LS _A	bar	LS _B	bar	
						c	
						b	
7	a	157B	157B	157B	16	157B	
	b	157B	LS _A	bar	LS _B	bar	
						c	
						b	
8	a	157B	157B	157B	16	157B	
	b	157B	LS _A	bar	LS _B	bar	
						c	
						b	
9	a	157B	157B	157B	16	157B	
	b	157B	LS _A	bar	LS _B	bar	
						c	
						b	
10	a	157B	157B	157B	16	157B	
	b	157B	LS _A	bar	LS _B	bar	
						c	
						b	
11	a	157B	157B	157B	16	157B	
	b	157B	LS _A	bar	LS _B	bar	
						c	
						b	
12	a	157B	157B	157B	16	157B	
	b	157B	LS _A	bar	LS _B	bar	
						c	
						b	
13	a	157B	157B	157B	16	157B	
	b	157B	LS _A	bar	LS _B	bar	
						c	
						b	
14	End section		157B				
15	PVAS section		157B				
	"Reserved for Painting"		157B				
Comments:							
Filled in by:						Date:	

Separate specification pads are available under the literature no. **520L0515**.



PVG 32 Proportional Valve Group
Technical Information
Notes



Products we offer:

- Bent Axis Motors
- Closed Circuit Axial Piston Pumps and Motors
- Displays
- Electrohydraulic Power Steering
- Electrohydraulics
- Hydraulic Power Steering
- Integrated Systems
- Joysticks and Control Handles
- Microcontrollers and Software
- Open Circuit Axial Piston Pumps
- Orbital Motors
- PLUS+1™ GUIDE
- Proportional Valves
- Sensors
- Steering
- Transit Mixer Drives

Members of the Sauer-Danfoss Group:

Comatrol

www.comatrol.com

Schwarz Müller-Inverter

www.schwarzmueller-inverter.com

Turolla

www.turollaocg.com

Valmova

www.valmova.com

Hydro-Gear

www.hydro-gear.com

Sauer-Danfoss-Daikin

www.sauer-danfoss-daikin.com

Sauer-Danfoss is a global manufacturer and supplier of high-quality hydraulic and electronic components. We specialize in providing state-of-the-art technology and solutions that excel in the harsh operating conditions of the mobile off-highway market. Building on our extensive applications expertise, we work closely with our customers to ensure exceptional performance for a broad range of off-highway vehicles.

We help OEMs around the world speed up system development, reduce costs and bring vehicles to market faster.

Sauer-Danfoss – Your Strongest Partner in Mobile Hydraulics.

Go to www.sauer-danfoss.com for further product information.

Wherever off-highway vehicles are at work, so is Sauer-Danfoss.

We offer expert worldwide support for our customers, ensuring the best possible solutions for outstanding performance. And with an extensive network of Global Service Partners, we also provide comprehensive global service for all of our components.

Please contact the Sauer-Danfoss representative nearest you.

Local address:

Sauer-Danfoss (US) Company
2800 East 13th Street
Ames, IA 50010, USA
Phone: +1 515 239 6000
Fax: +1 515 239 6618

Sauer-Danfoss ApS
DK-6430 Nordborg, Denmark
Phone: +45 7488 4444
Fax: +45 7488 4400

Sauer-Danfoss GmbH & Co. OHG
Postfach 2460, D-24531 Neumünster
Krokamp 35, D-24539 Neumünster, Germany
Phone: +49 4321 871 0
Fax: +49 4321 871 122

Sauer-Danfoss-Daikin LTD.
Shin-Osaka TERASAKI 3rd Bldg. 6F
1-5-28 Nishimiyahara, Yodogawa-ku
Osaka 532-0004, Japan
Phone: +81 6 6395 6066
Fax: +81 6 6395 8585